













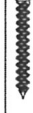
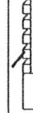

A	517x326	1x
B	550x350	1x
C	363x328	1x
D	363x328	1x
G	533x362	1x
J	543x356	1x

Colli 1/2

Z2		1x
Z1		4x
Z29		8x
Z30		8x
Z33		8x

Colli 2/2

Z16		4x
Z38		2x
Z39		4x
Z81		2x
Z156		12x
Z166		1x
Z170		1x
Z191		2x
Z192		1x
Z193		1x
Z194		2x
Z211		2x

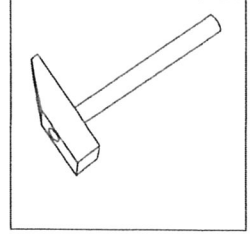
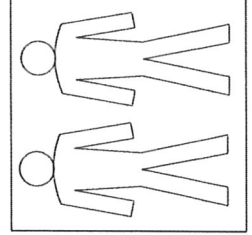
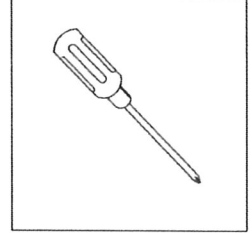
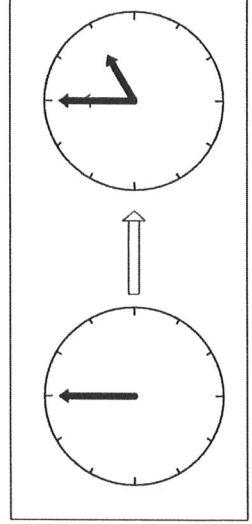
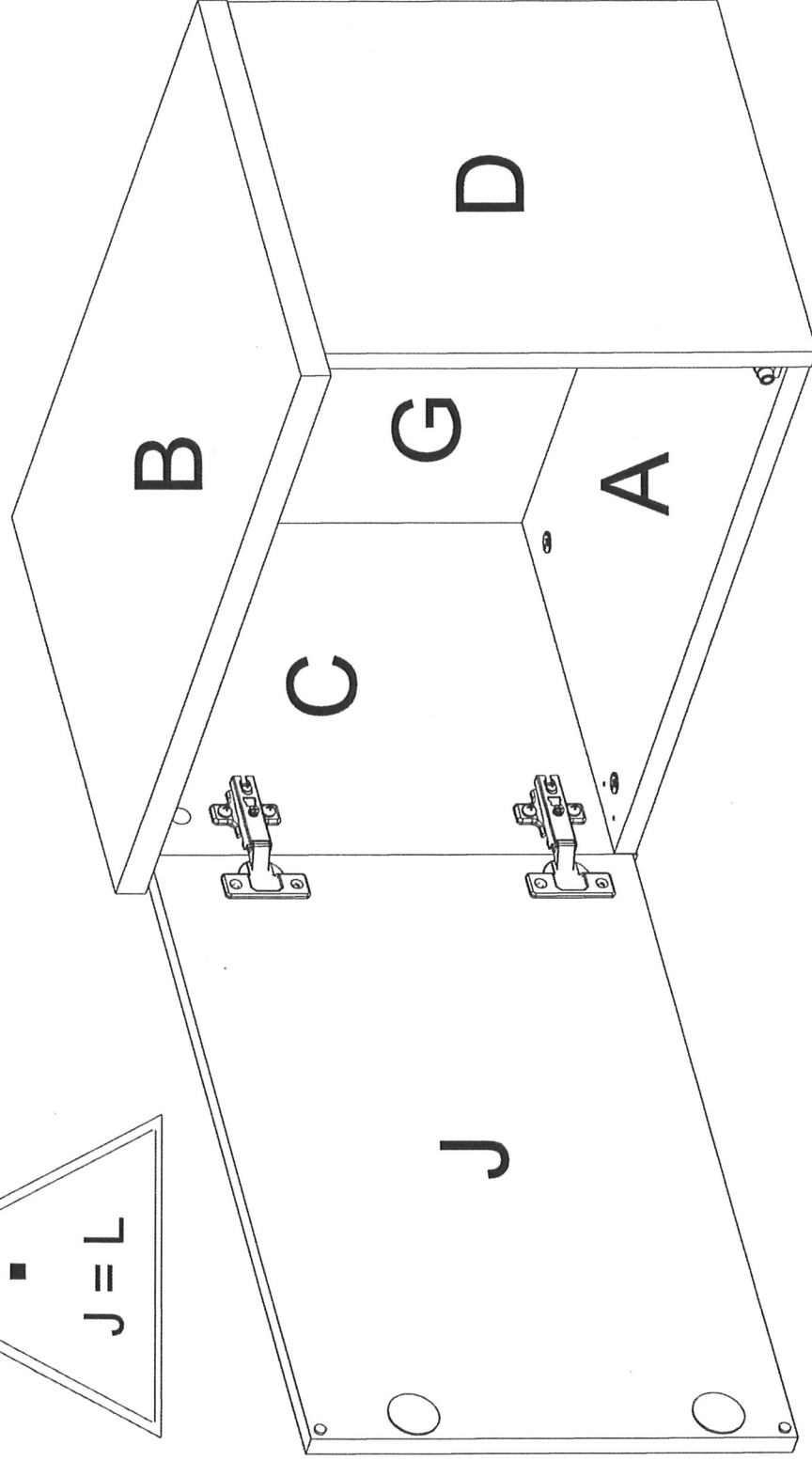
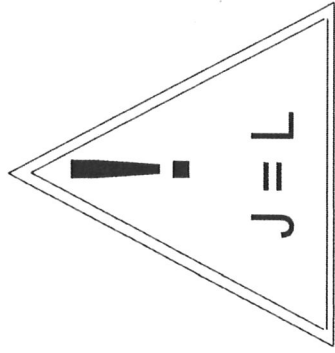

MX30ND

1.

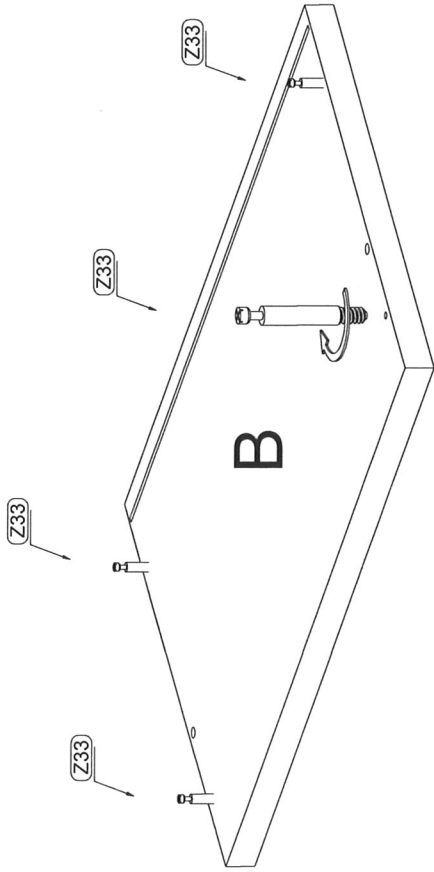

Z33		4x
-----	--	----

B	550x350	1x
---	---------	----

2.

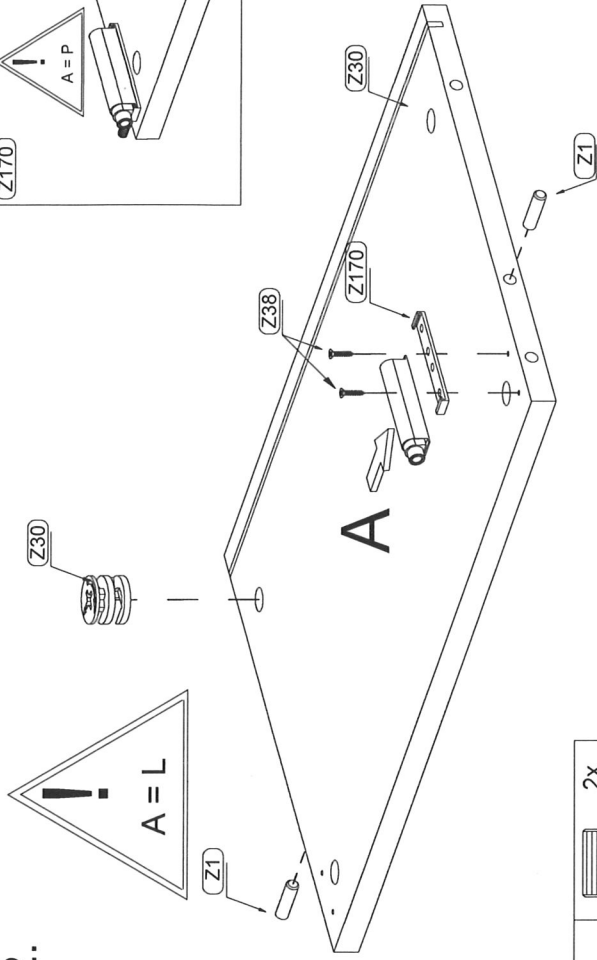

Z1		2x
Z30		4x
Z38		2x
Z170		1x

A	517x326	1x
---	---------	----

3.

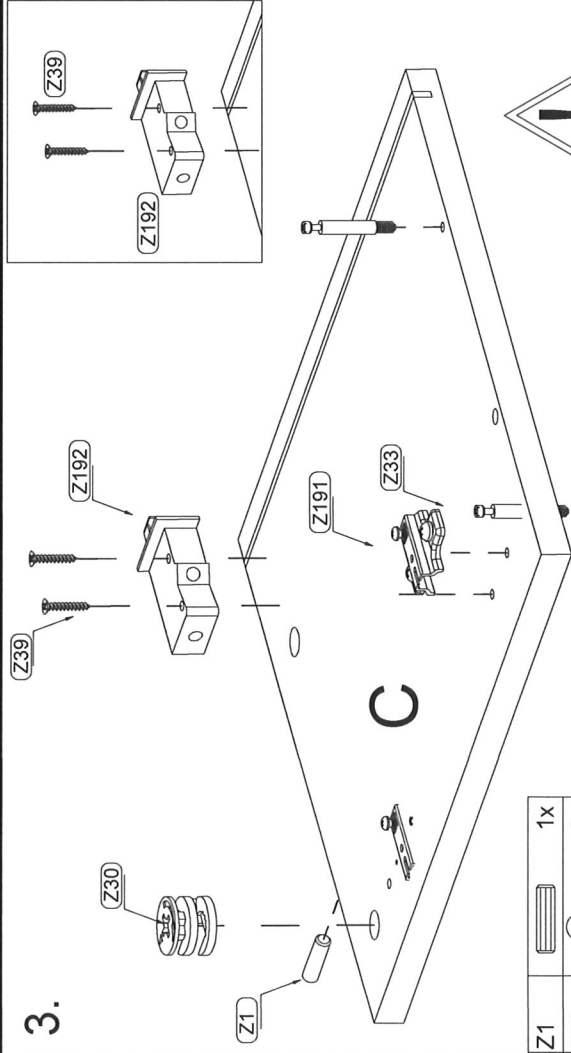

Z1		1x
Z30		2x
Z33		2x
Z39		2x
Z191		2x
Z192		1x

C	363x328	1x
---	---------	----

4.

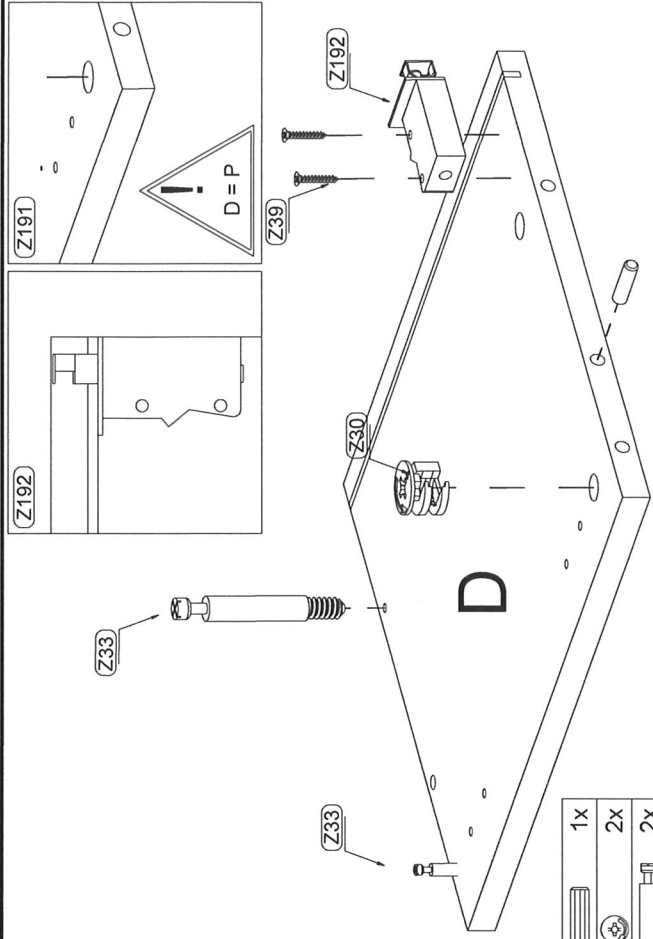

Z1		1x
Z30		2x
Z33		2x
Z39		2x
Z193		R
		1x

D	363x328	1x
---	---------	----

