

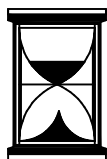

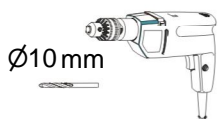

**A****S256-REG/20/11****40min**

A	B	C (mm)		D
1	S256-159	1975	311	2/2
2	S256-160	1975	311	2/2
3	S256-217	1100	340	1/2
4	S256-350	1012	291	1/2
5	S256-351	1011	291	1/2
6	S256-5551	1975	80	2/2
7	S256-5553	1975	80	2/2
8	S256-5554	1975	58	2/2
9	S256-5555	928	80	1/2
10	S256-9907	1908	1023	2/2

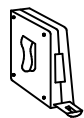
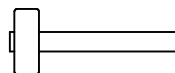
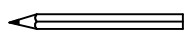
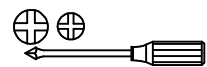
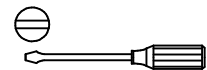
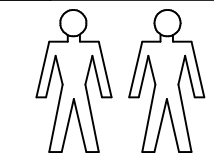
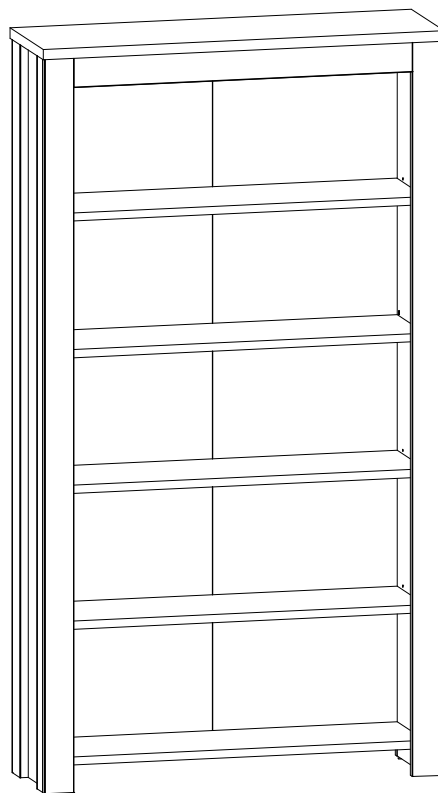
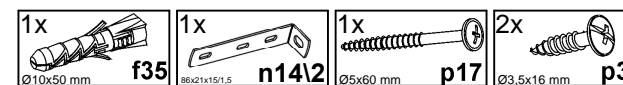
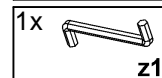
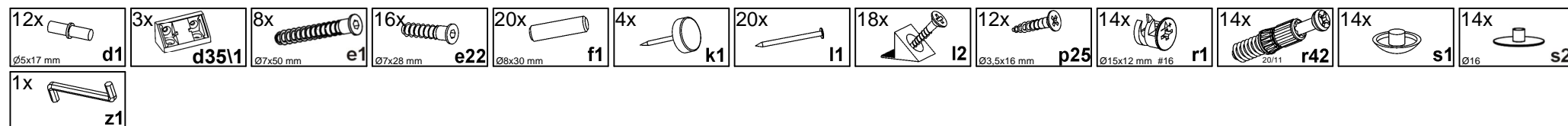
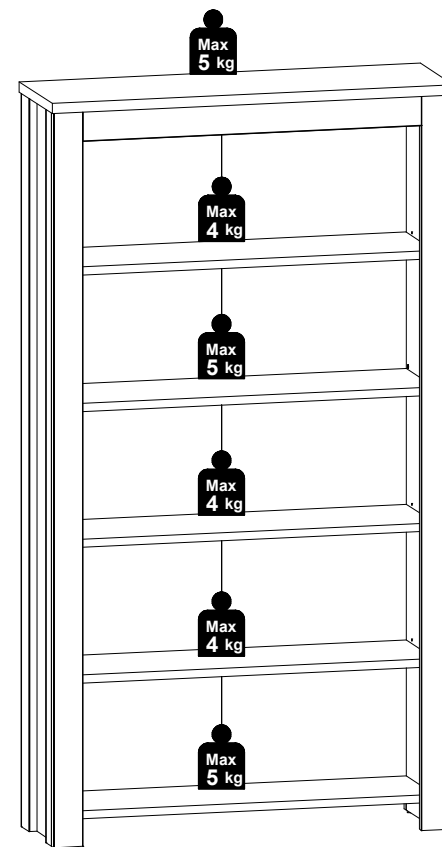
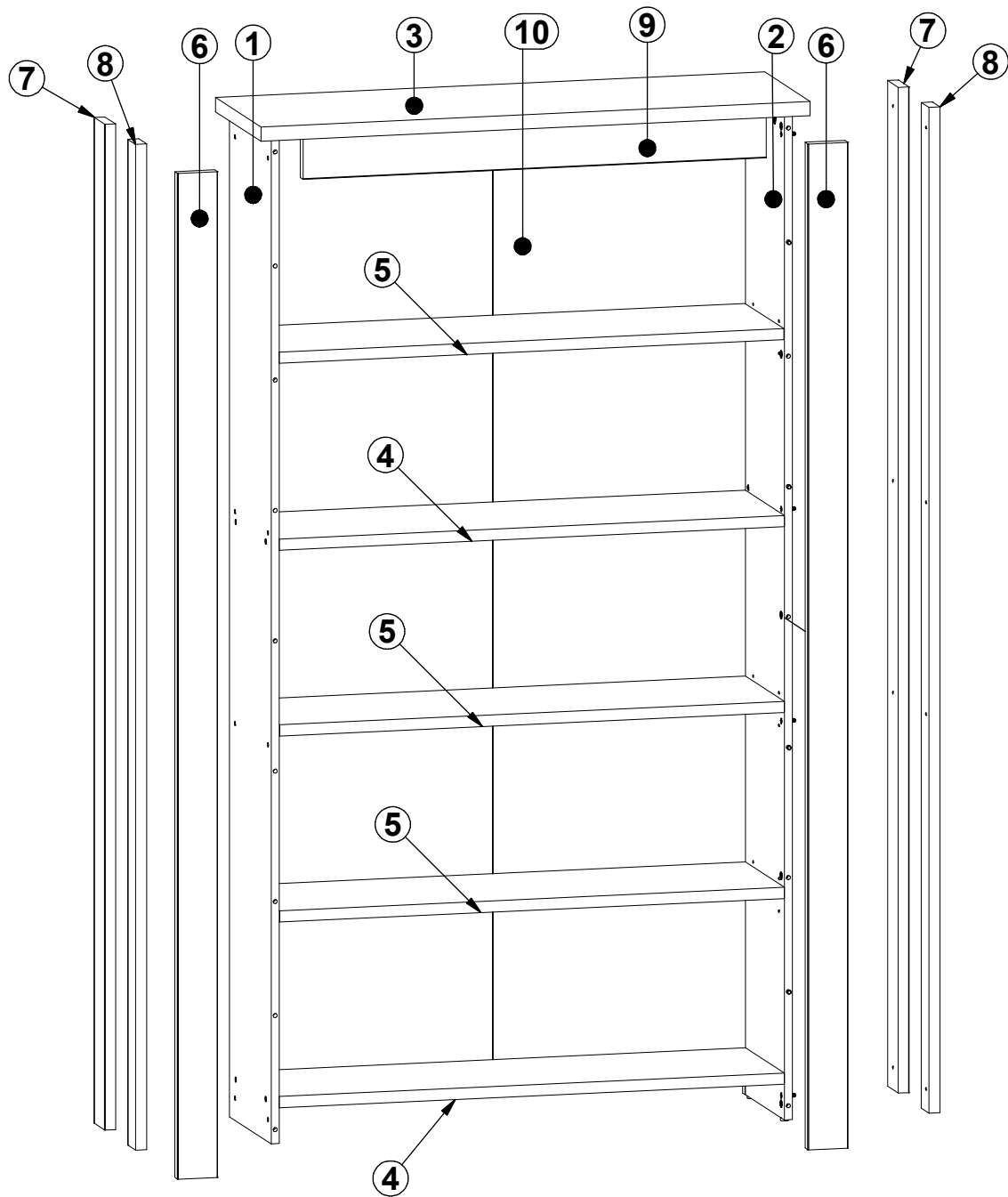
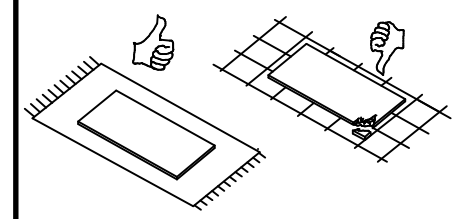
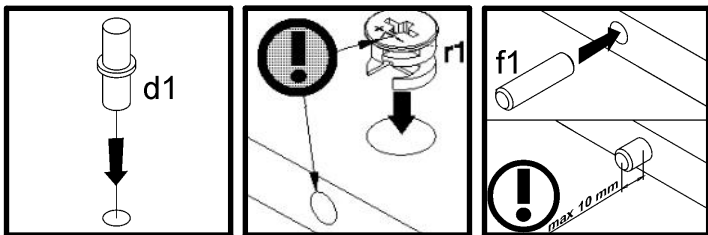





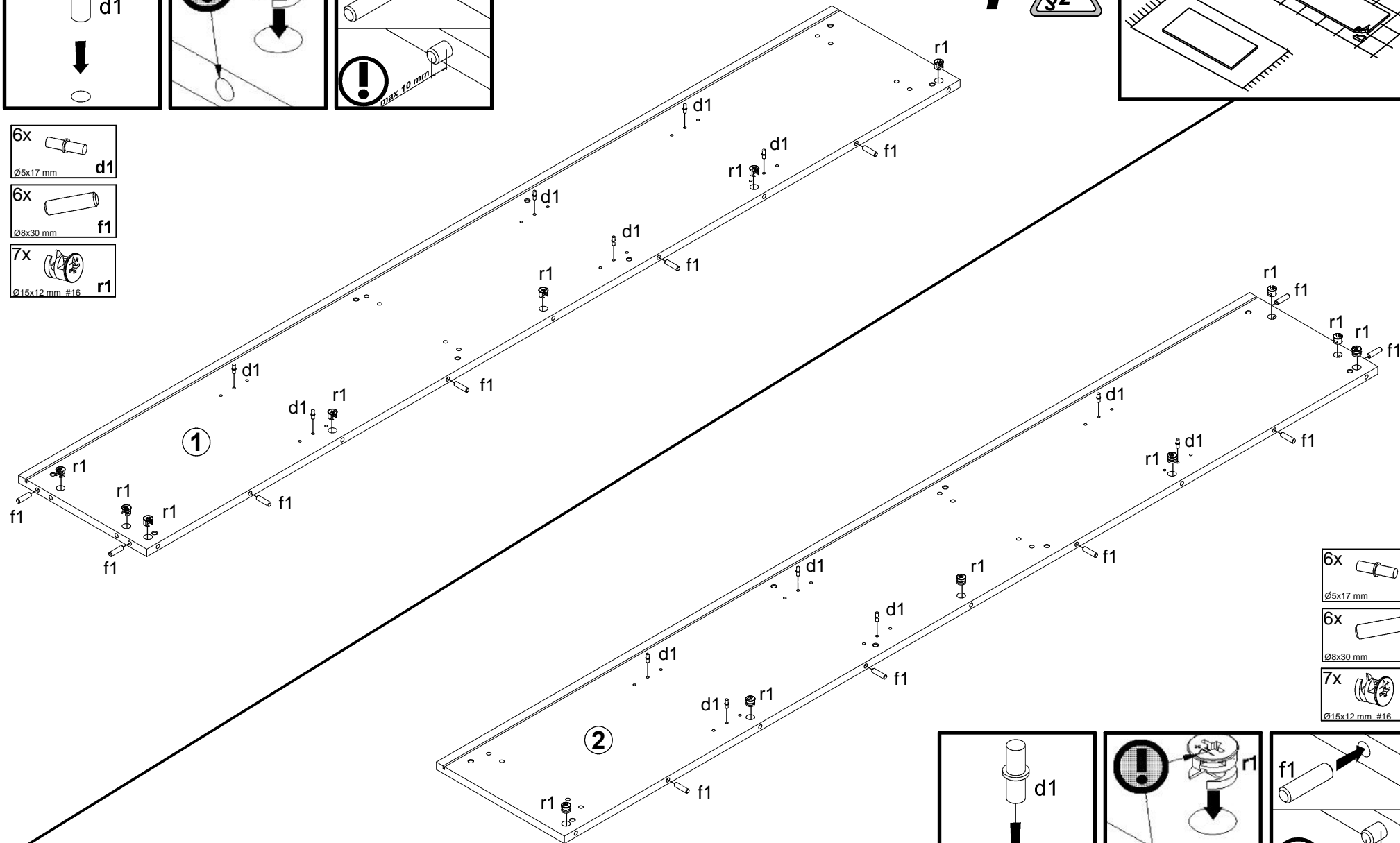

- 6x  **d1**  
∅5x17 mm
- 6x  **f1**  
∅8x30 mm
- 7x  **r1**  
∅15x12 mm #16



- 6x  **d1**  
∅5x17 mm
- 6x  **f1**  
∅8x30 mm
- 7x  **r1**  
∅15x12 mm #16

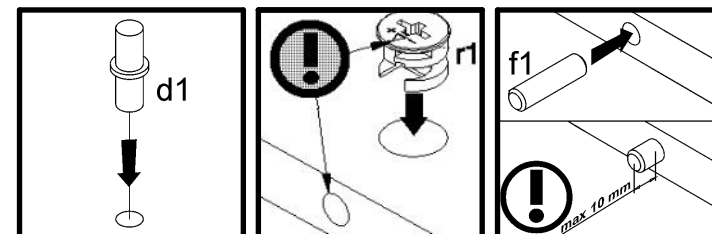

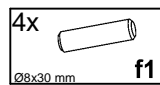
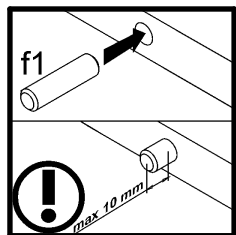

1

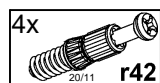
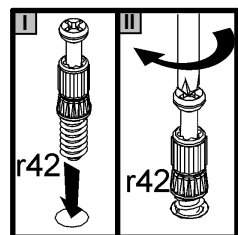
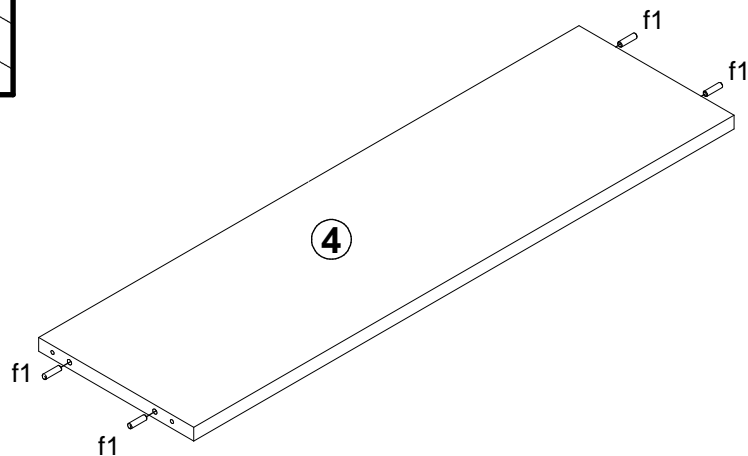

3

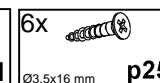
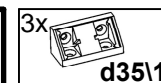
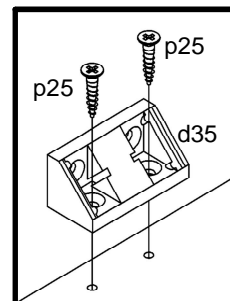
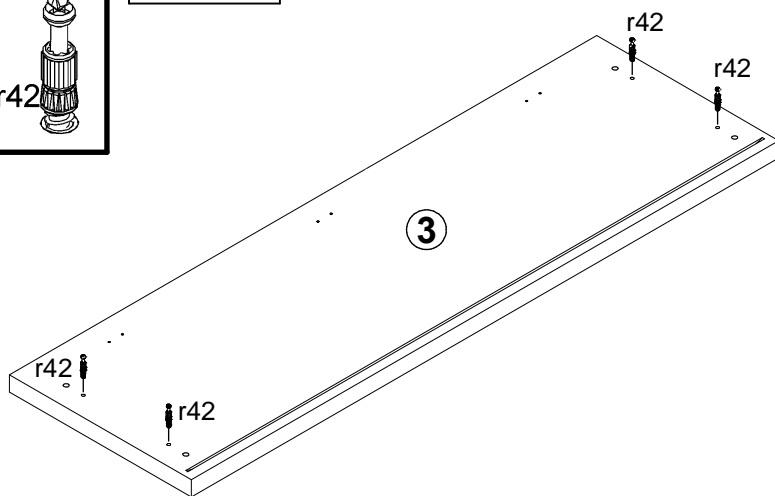

9

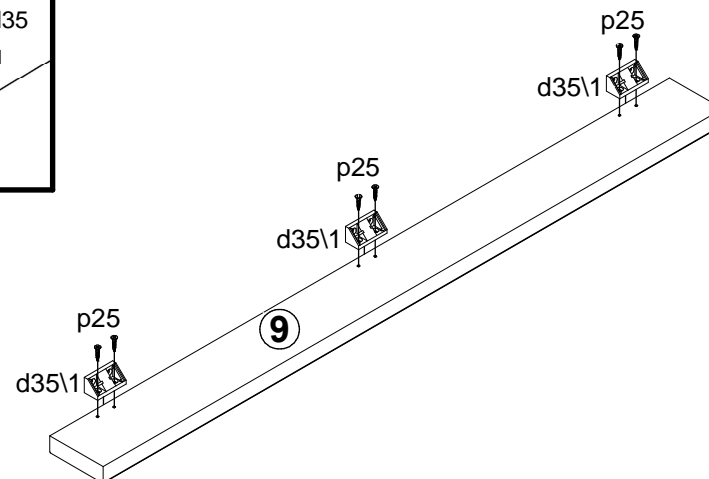

2 

3

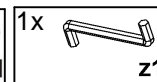
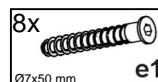
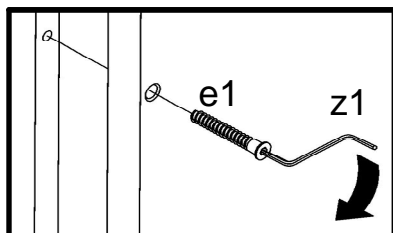
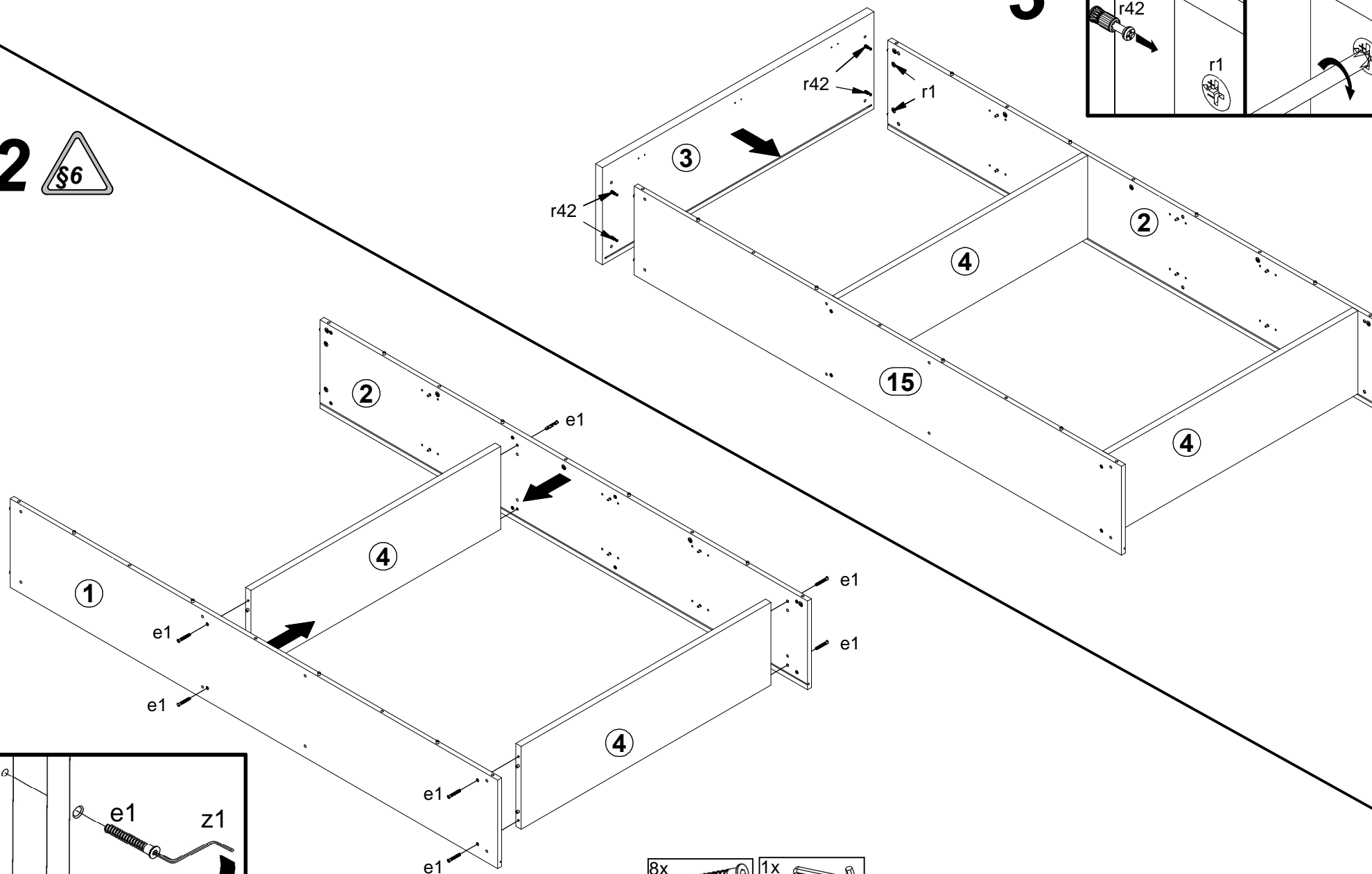
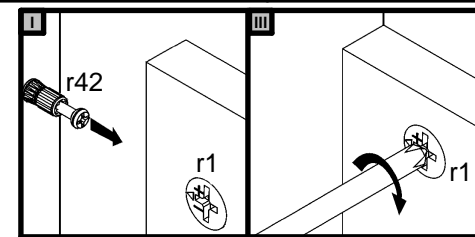



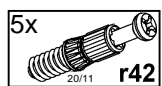
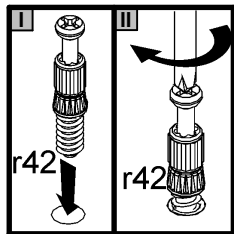

6

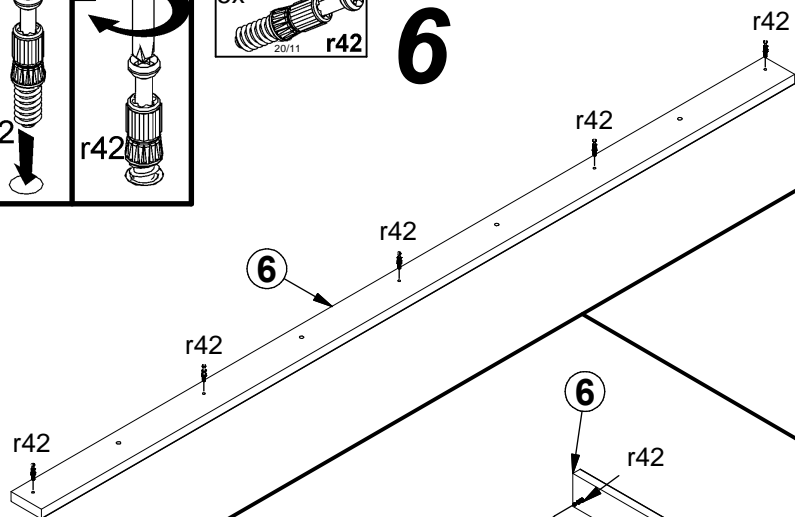

8

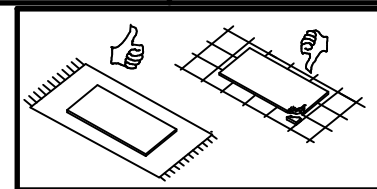

7

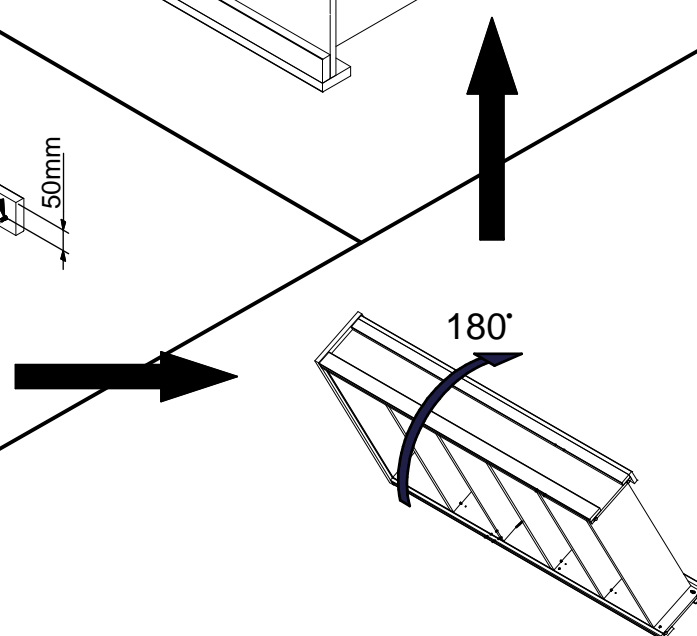
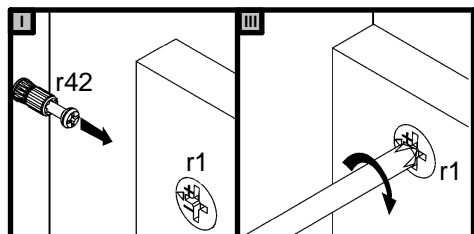
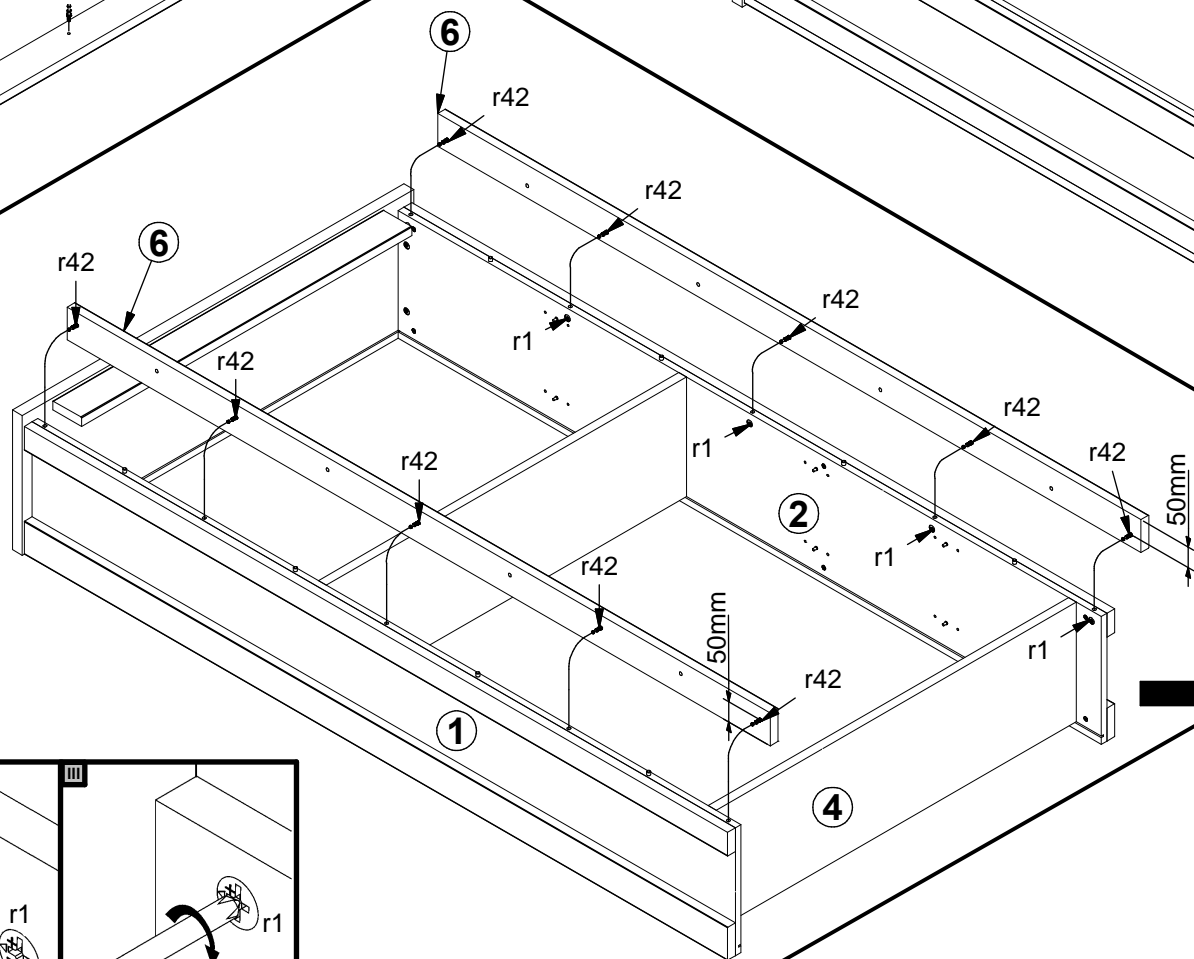



9

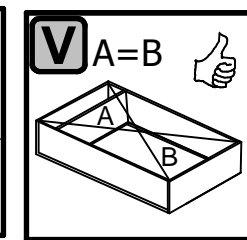
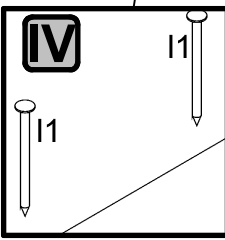
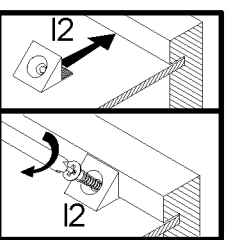
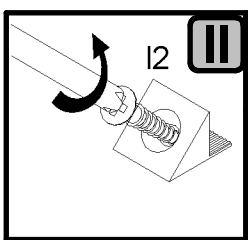
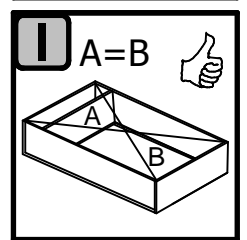
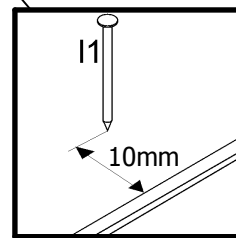
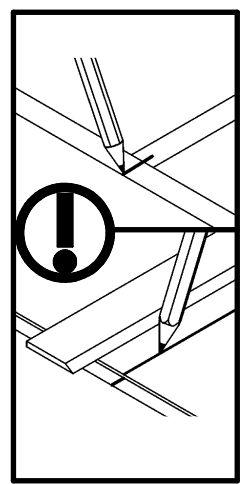
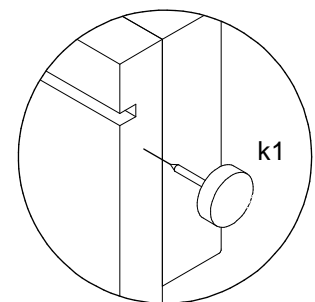
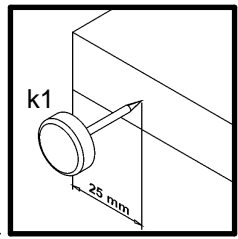
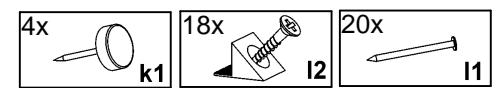
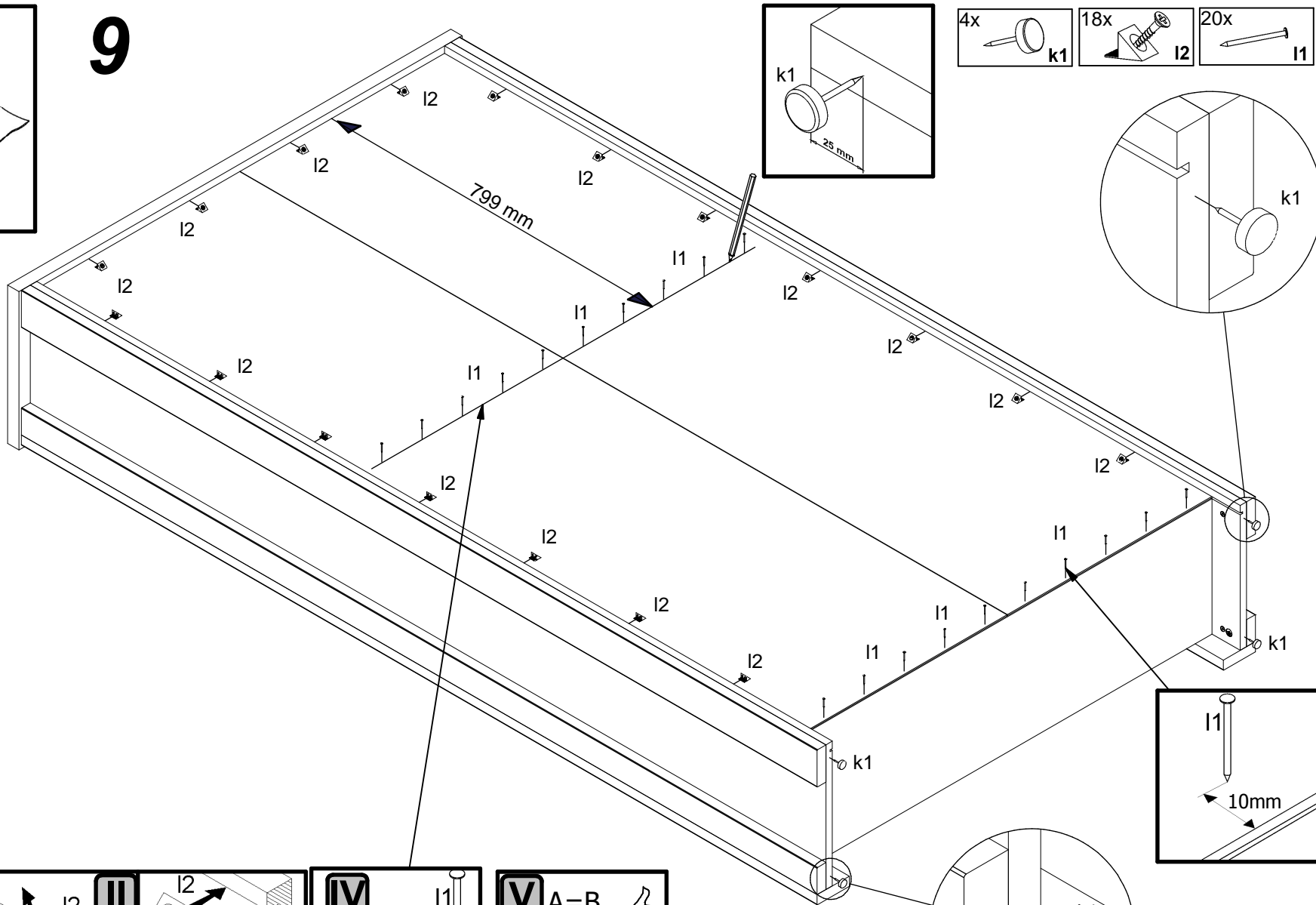
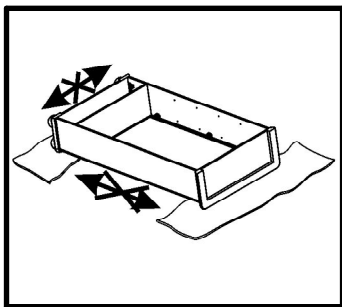

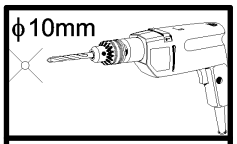

10

