

A	B	C (mm)		D
1	S263-1001	599	168	1/1
2	S263-1002	567	168	1/1
3	S263-1003	283	168	1/1
4	S263-1004	301	168	1/1
5	S263-2001	600	600	1/1
6	S263-2002	600	600	1/1
7	S263-4001	712	100	1/1
8	S263-4002	348	100	1/1

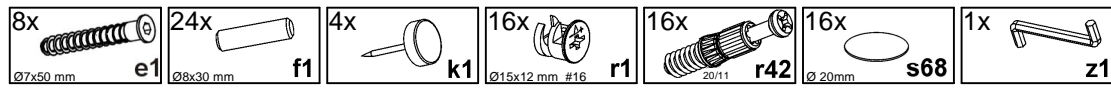
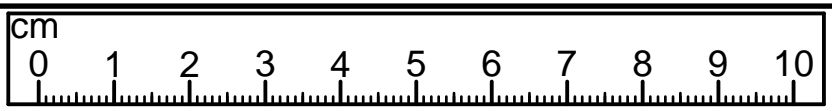
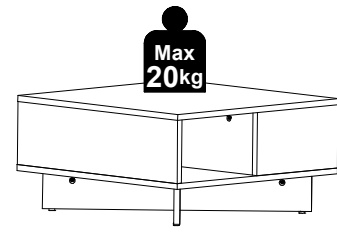

1

2x  $\varnothing 15 \times 12 \text{ mm \#16}$  r1

2x  $\varnothing 8 \times 30 \text{ mm}$  f1

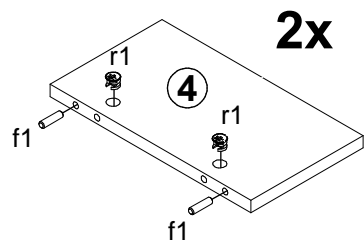

2x  $\varnothing 15 \times 12 \text{ mm \#16}$  r1

4x  $\varnothing 8 \times 30 \text{ mm}$  f1

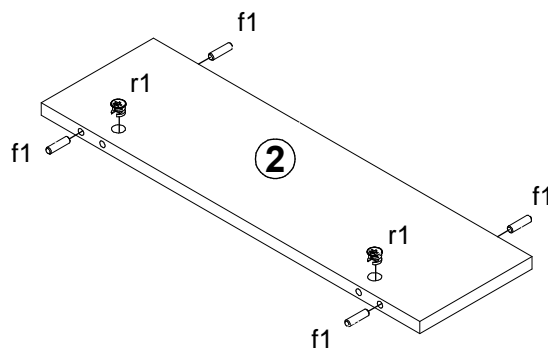

2x  $\varnothing 15 \times 12 \text{ mm \#16}$  r1

4x  $\varnothing 8 \times 30 \text{ mm}$  f1

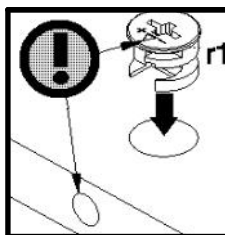
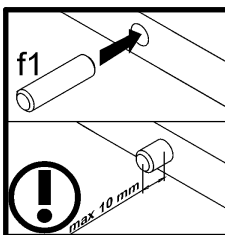
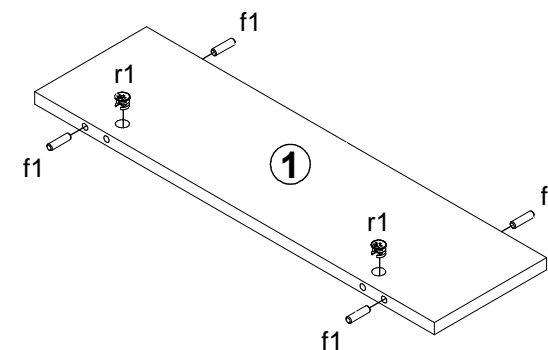

4x  $\varnothing 8 \times 30 \text{ mm}$  f1

4x  $\varnothing 15 \times 12 \text{ mm \#16}$  r1

4x  $\varnothing 8 \times 30 \text{ mm}$  f1

2x  $\varnothing 15 \times 12 \text{ mm \#16}$  r1

2x  $\varnothing 8 \times 30 \text{ mm}$  f1

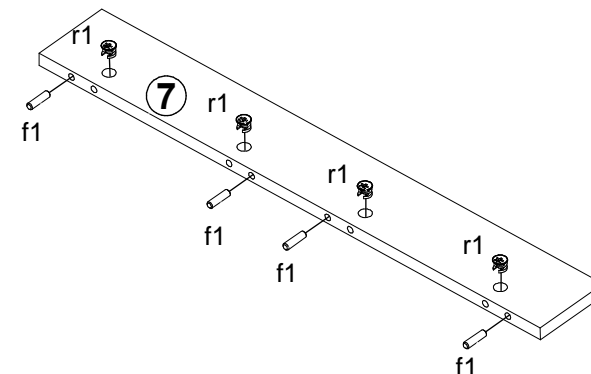
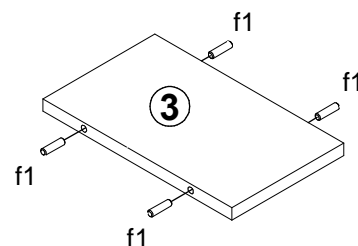
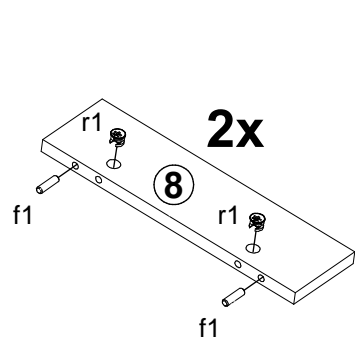

A

S263-LAW/3/6

4 / 6

1

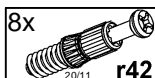
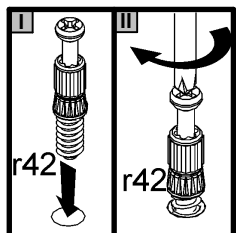
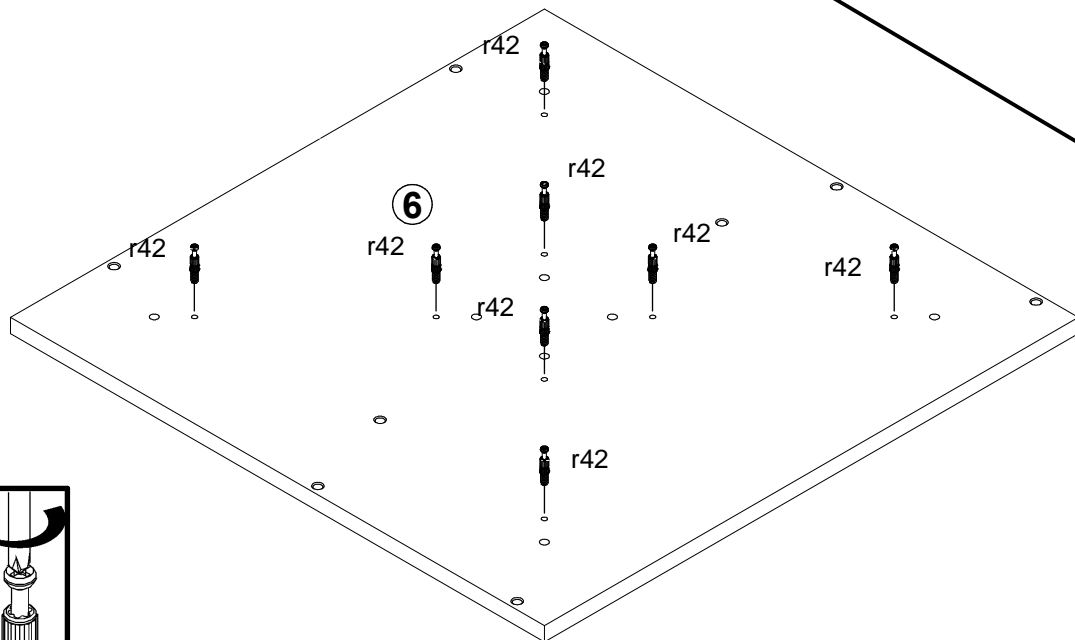
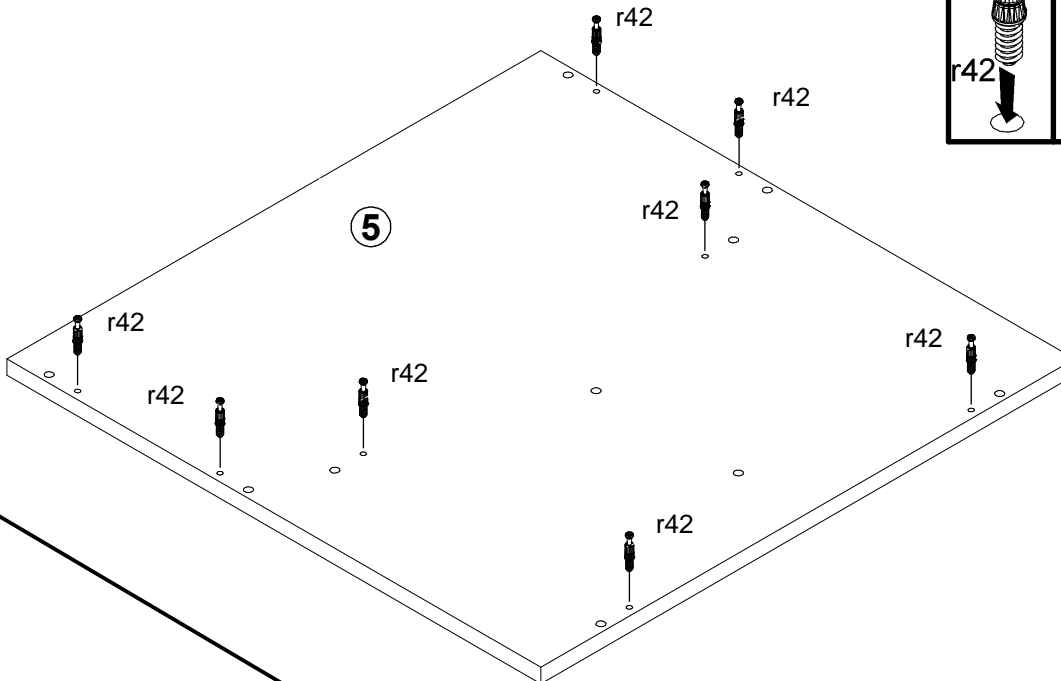
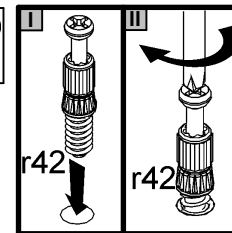
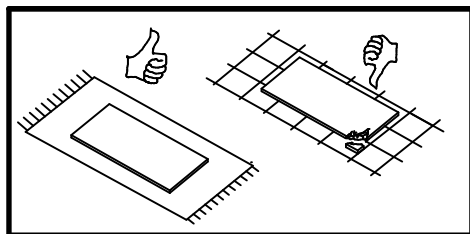

2

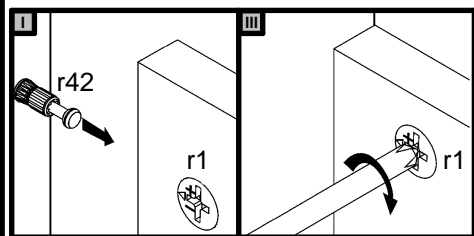
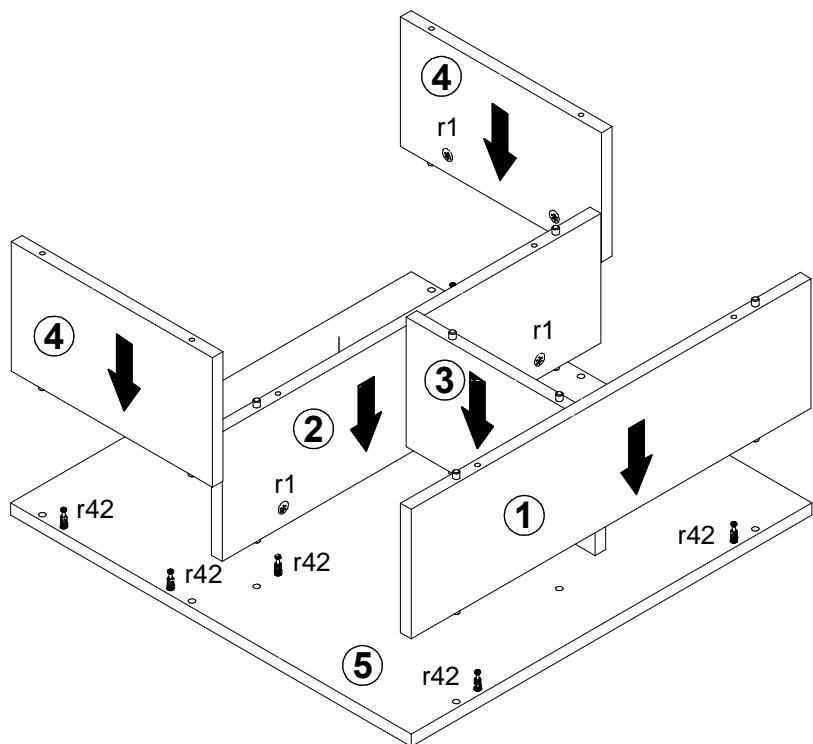

3

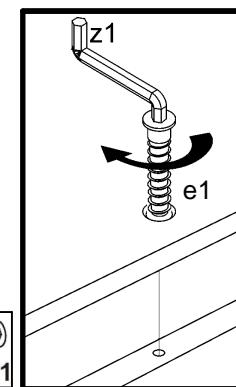
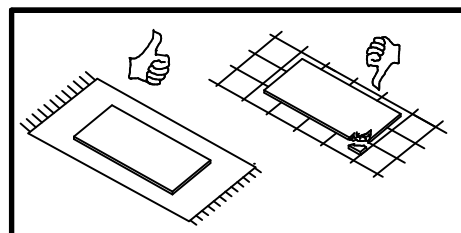
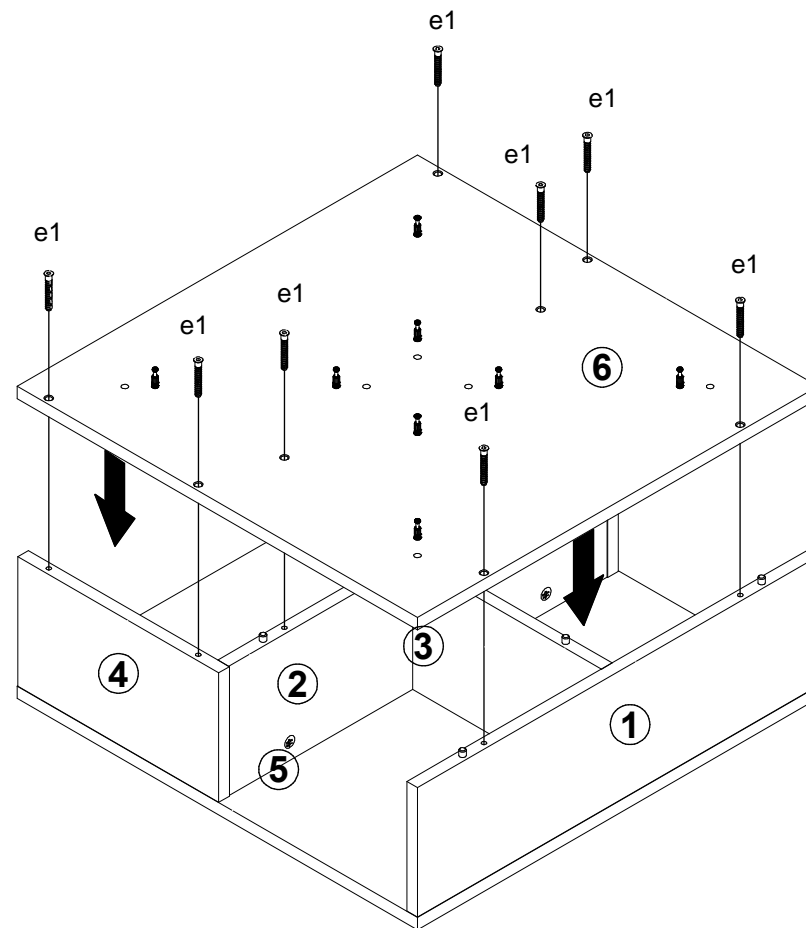

4

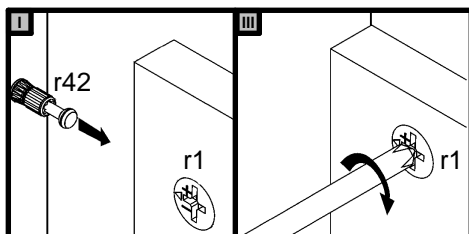
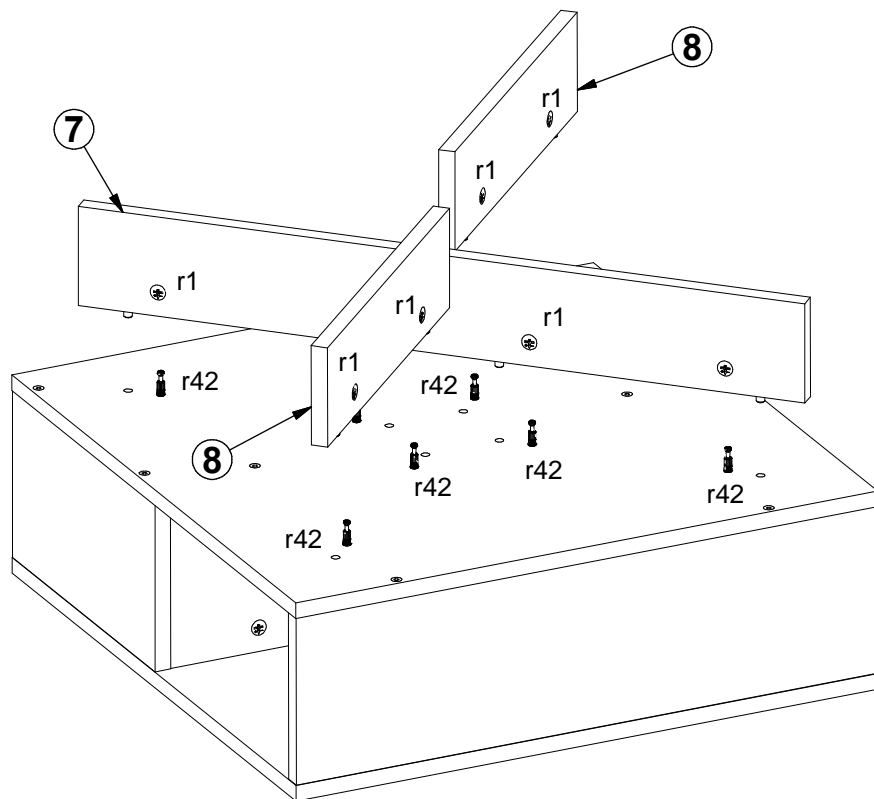

5

