

A	B	C (mm)		D
1	S261-1011	368	400	1/1
2	S261-1012	368	380	1/1
3	S261-1016	368	380	1/1
4	S261-2005	1597	400	1/1
5	S261-9007	378	1574	1/1

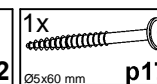

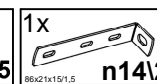

x2

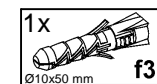
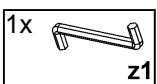
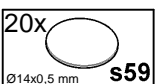
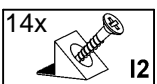
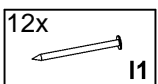
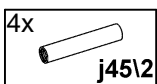
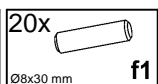
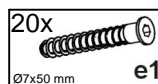
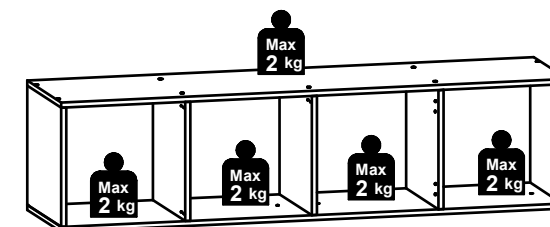
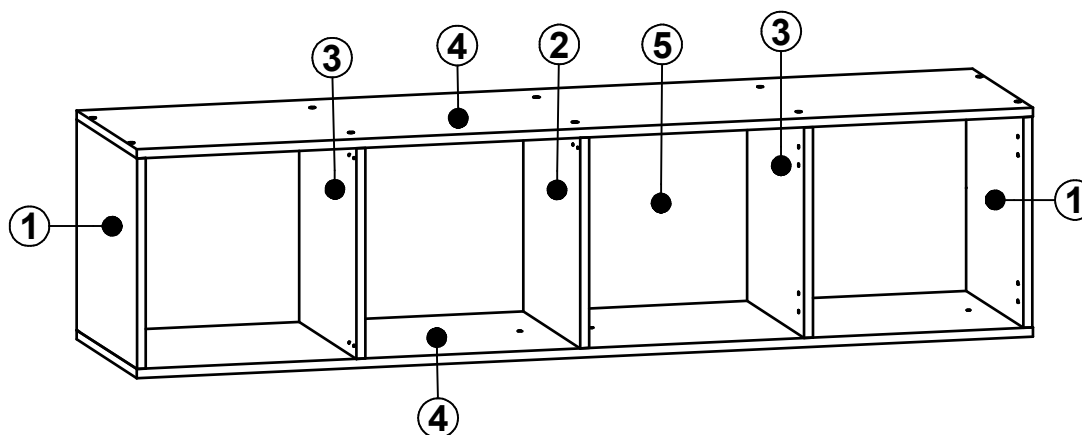
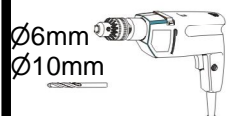
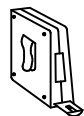
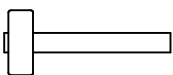
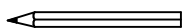
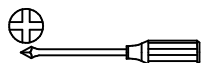
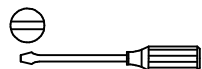
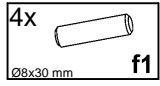
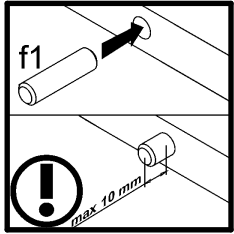
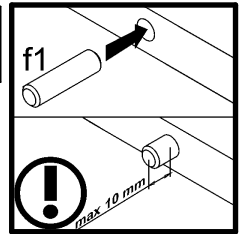
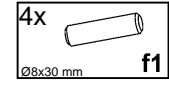
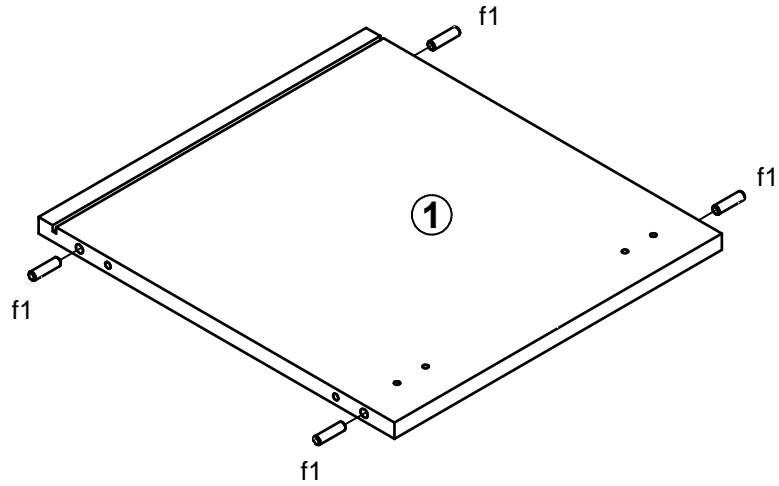

2x

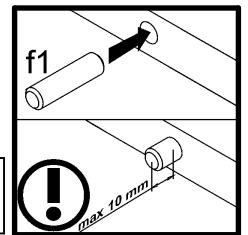
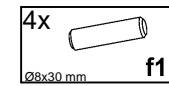
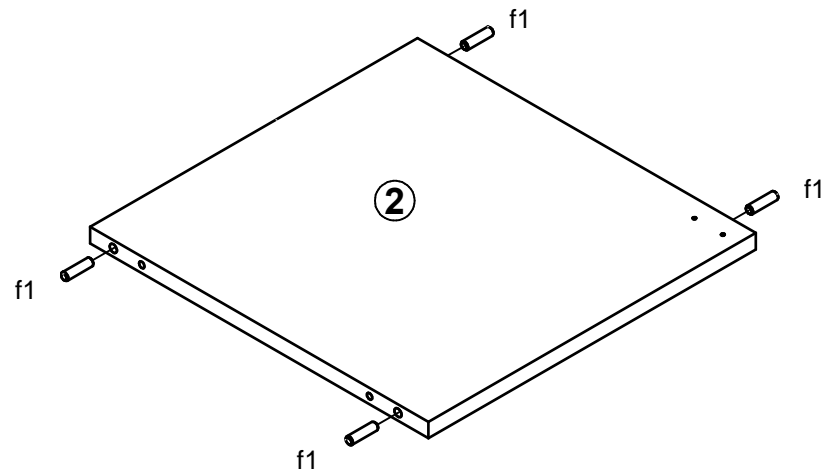
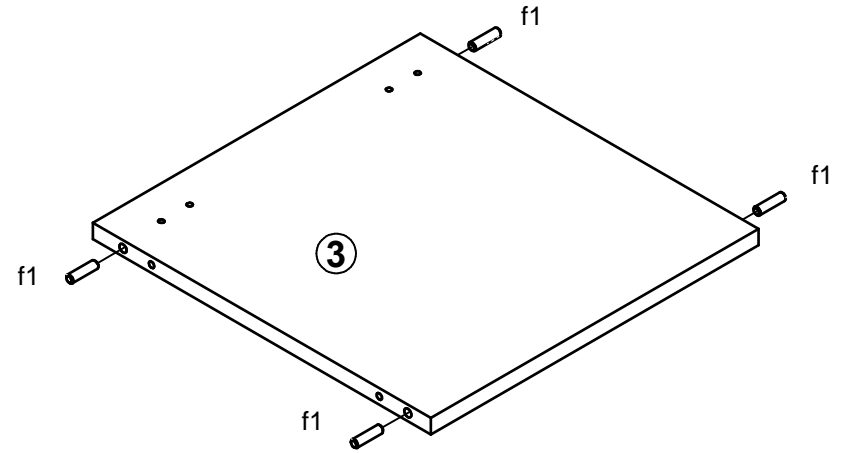

2

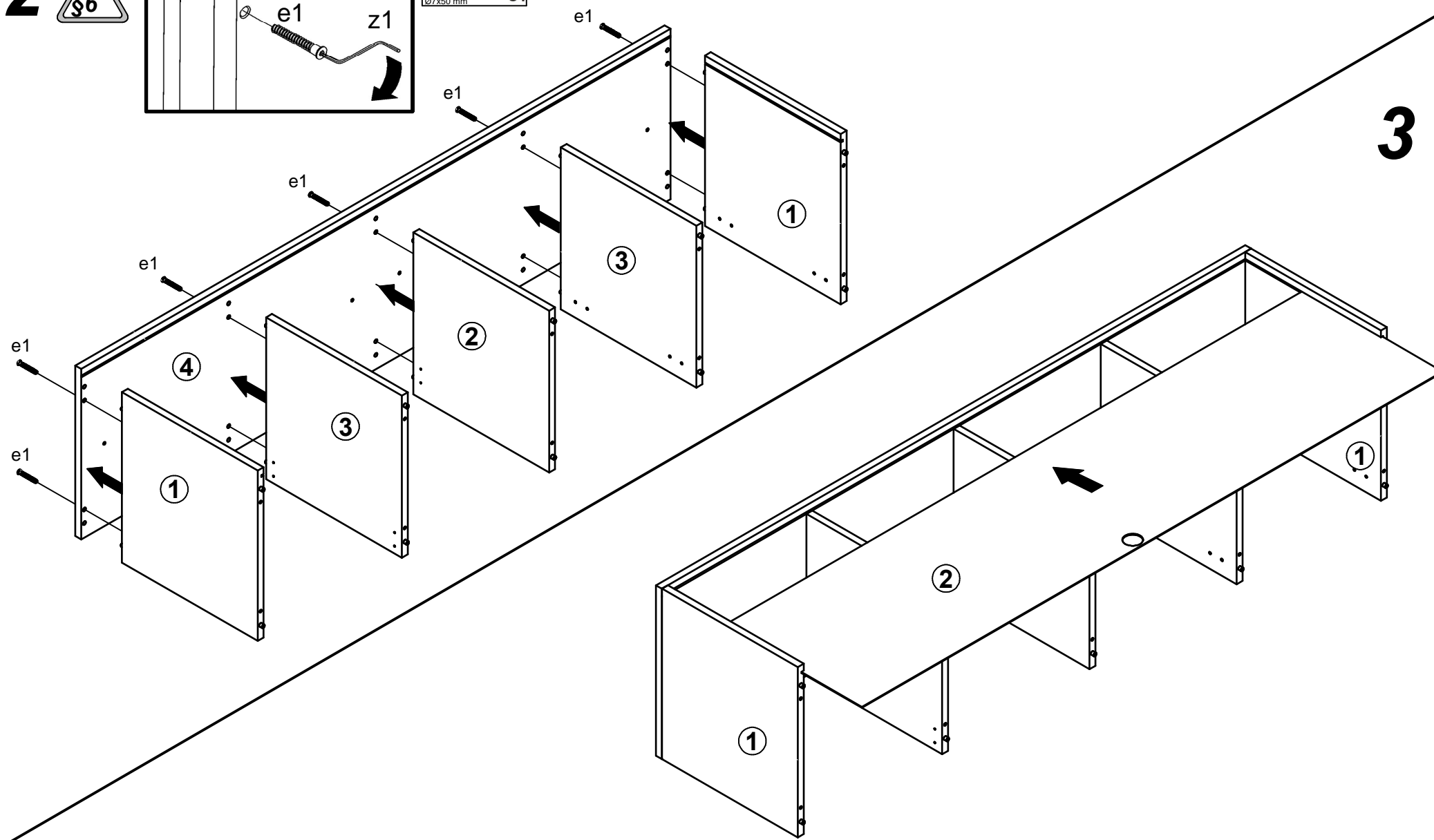
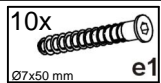
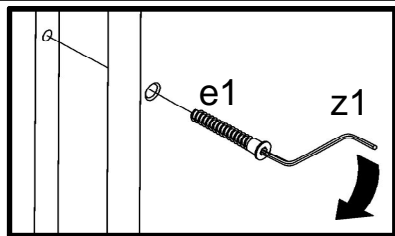

4

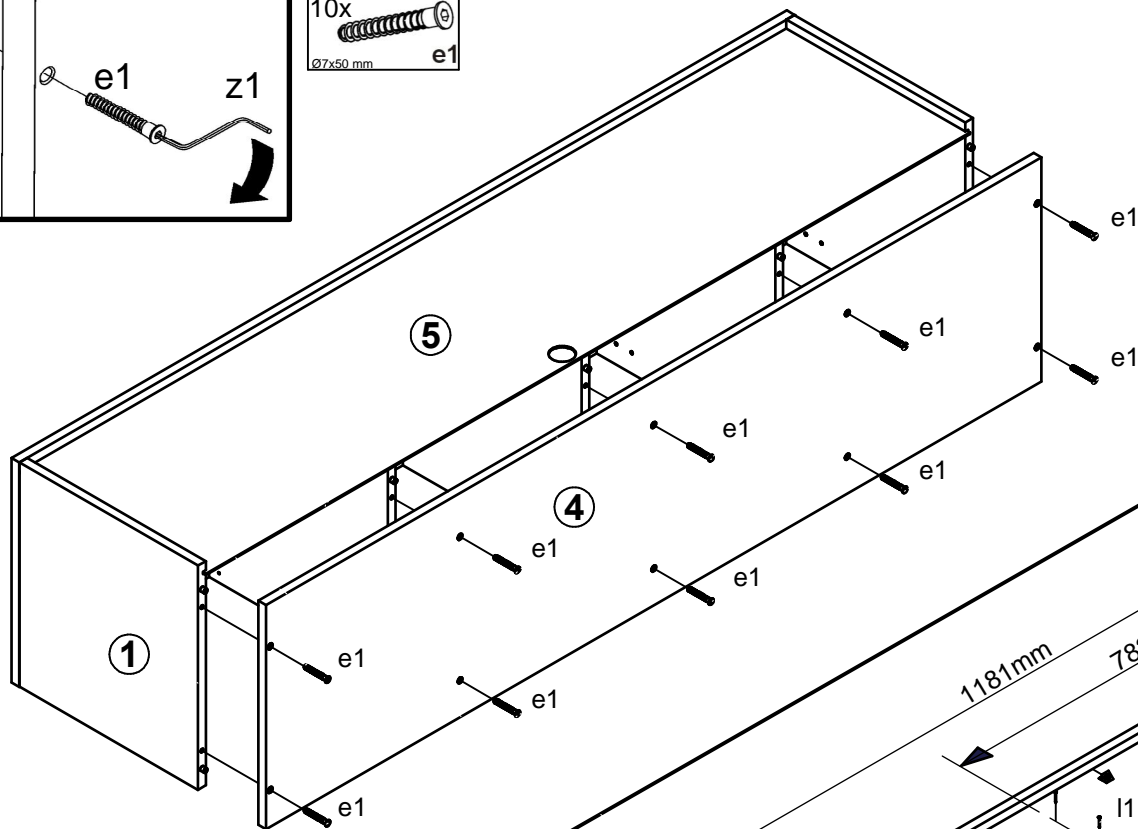
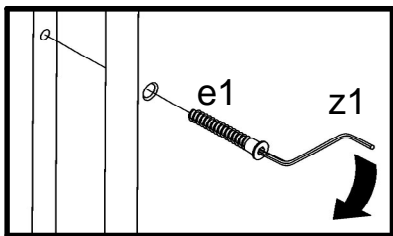

5

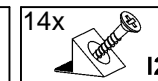
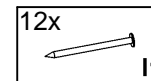
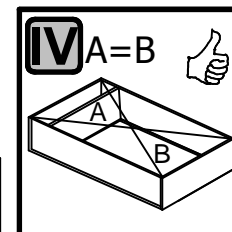
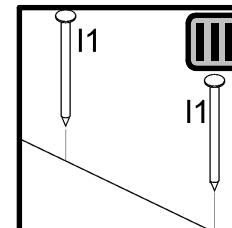
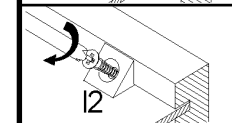
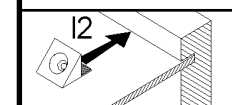
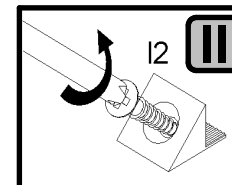
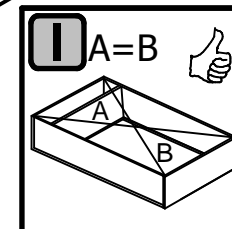
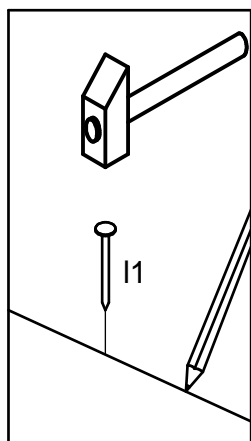
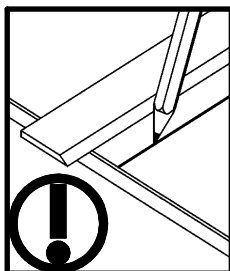
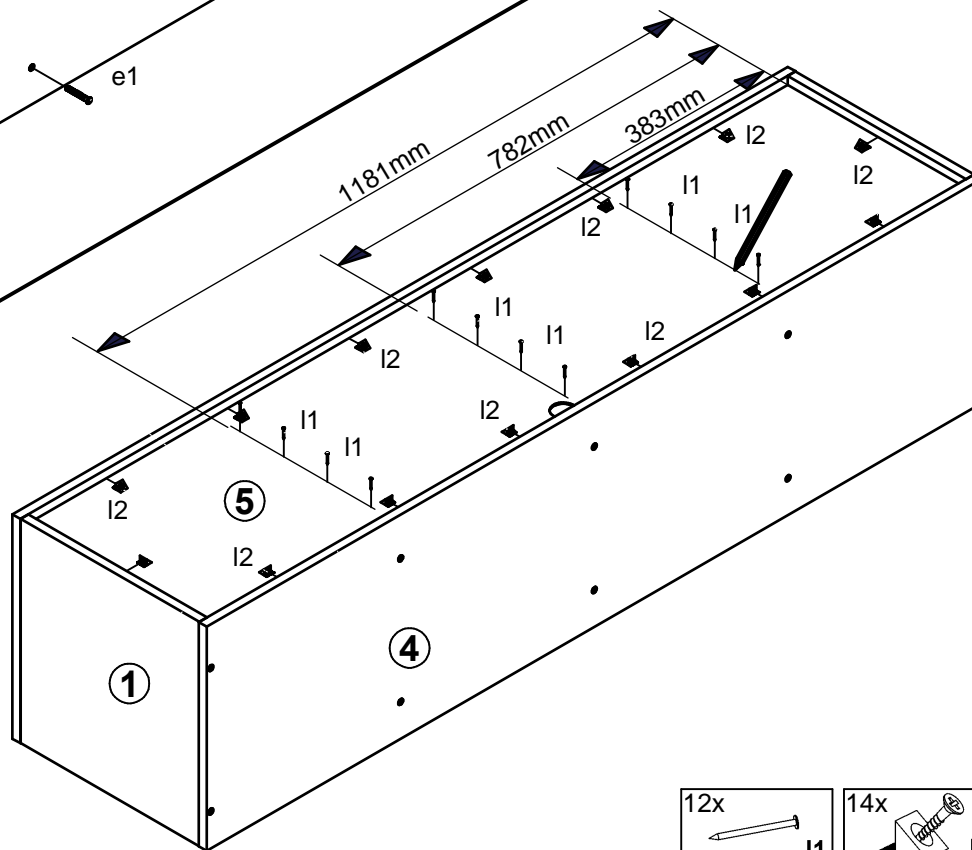

6

