

A

ACADEMICA

S324-KOM3D3S

A	B	C	D	A	B	C	D		
1	S324-005	396	644	3/3	12	S324-310	1170	332	1/3
2	S324-006	396	644	3/3	13	S324-316	379	327	2/3
3	S324-013	396	196	3/3	14	S324-317	774	327	2/3
4	S324-014	396	196	3/3	15	S324-406	1170	60	1/3
5	S324-015	396	196	3/3	16	S324-912	353	305	1/3
6	S324-110	881	332	2/3	17	S324-914	876	795	1/3
7	S324-111	881	332	2/3	18	S324-915	876	400	1/3
8	S324-117	225	308	2/3	19	ZS3-5503	331	120	2/3
9	S324-118	225	308	2/3	20	ZS4-507	300	120	2/3
10	S324-119	626	332	2/3	21	ZS4-508	300	120	2/3
11	S324-205	1201	332	1/3					

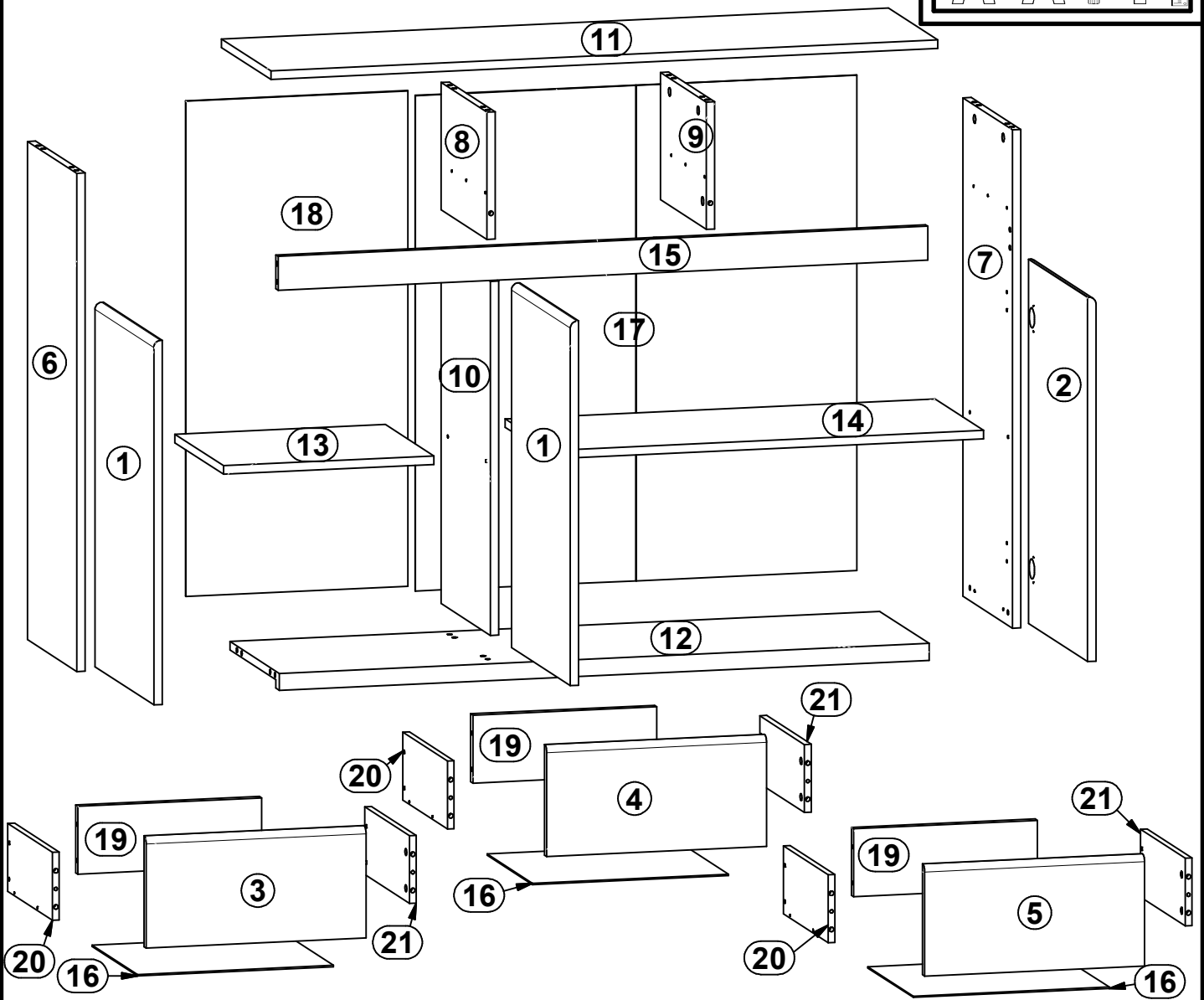
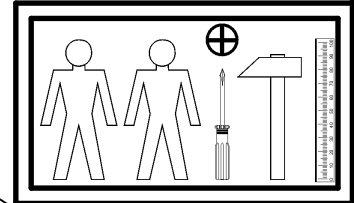
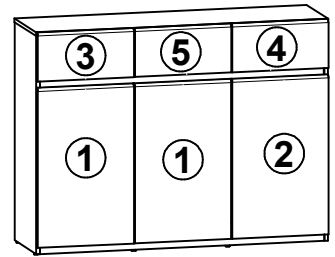

4x a44	2x a68	4x b19	2x b35	8x d1 Ø5x17 mm	2x e1 Ø7x50 mm	18x e3 Ø6x13 mm	12x e19 Ø5x9 mm	20x f1 Ø8x30 mm
6x f9 Ø6x30 mm	12x f25 Ø6.5x40 mm	5x k1	60x l1	10x o21 silikon	9x p38 Ø3.5x16 mm	12x p51 Ø3.5x15 mm	18x r1 Ø15x12 mm #16	12x r15 Ø12x10.5 mm #12
26x r42	2x r51	2x s62	3x w37 CL 300 mm	3x w37 CR 300 mm	3x w37 DL 300 mm	3x w37 DR 300 mm	1x z1	1x n26 1
1x p38 Ø3.5x16 mm	4x s2 Ø16							

1 

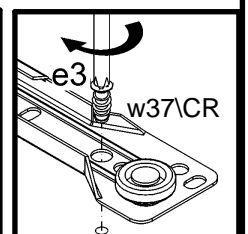
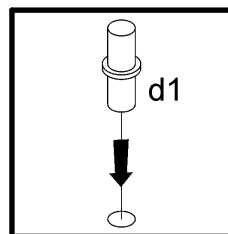
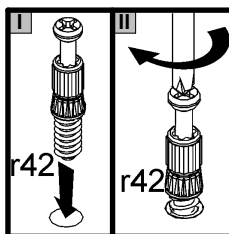
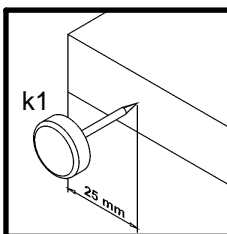
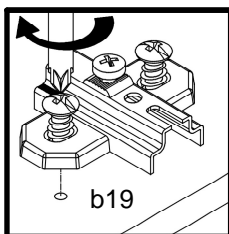
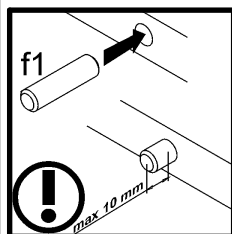
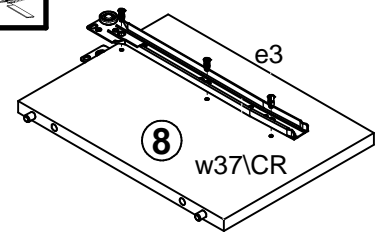
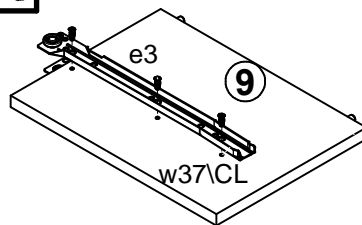
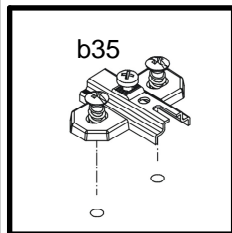
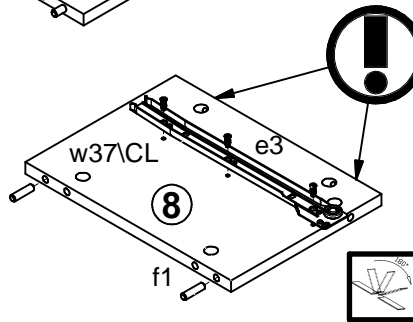
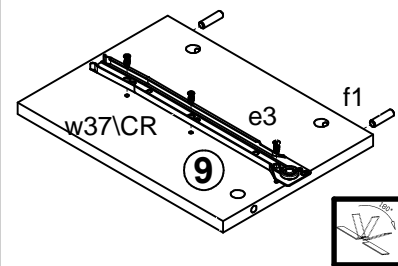
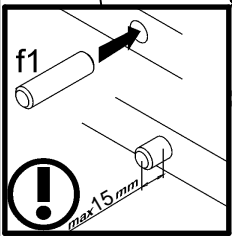
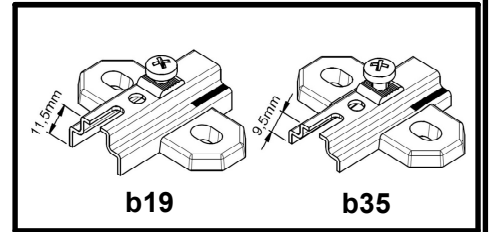
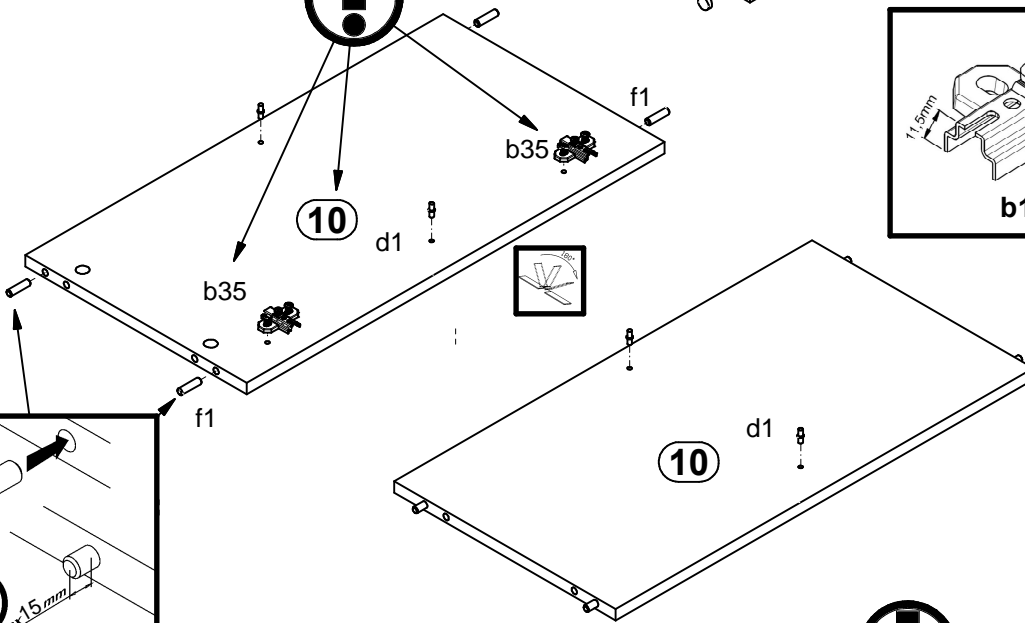
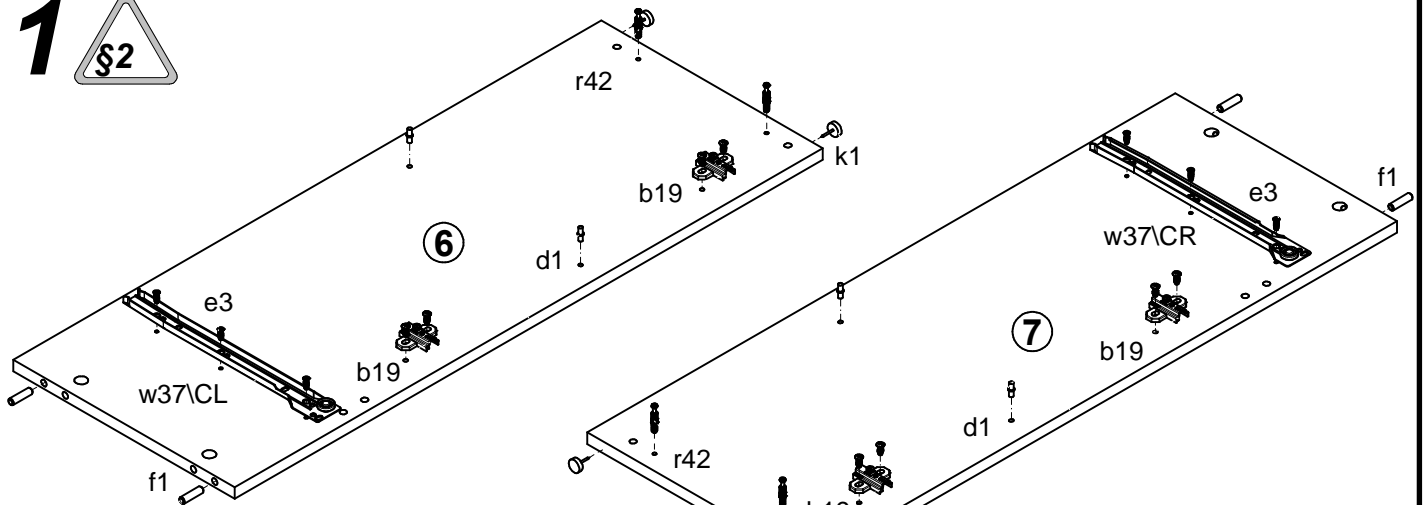

2 

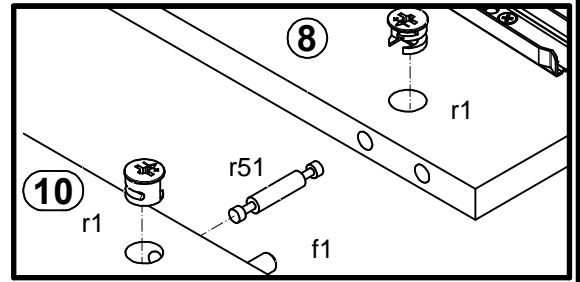
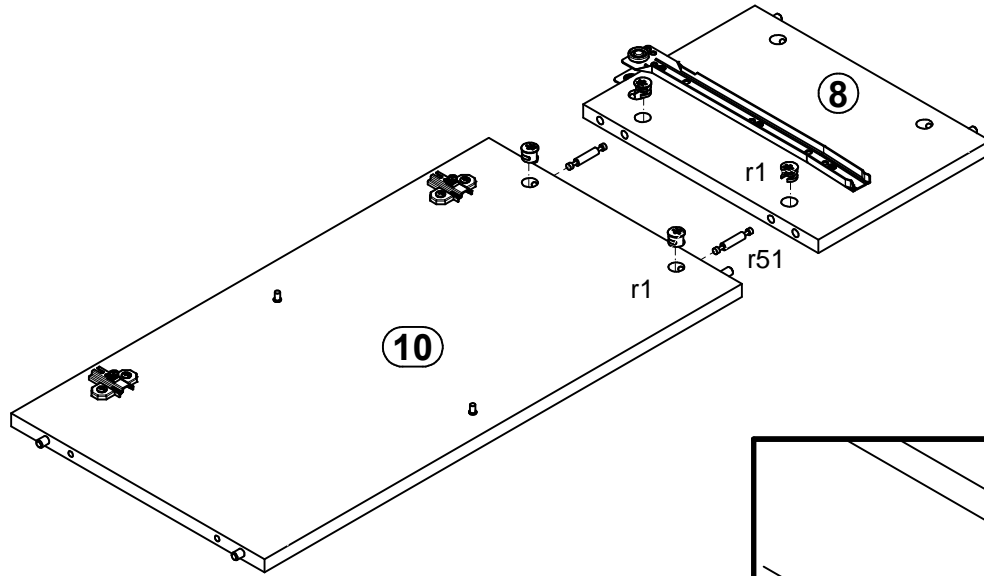

3

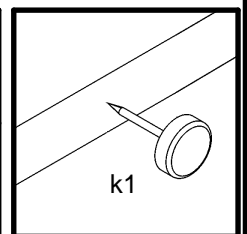
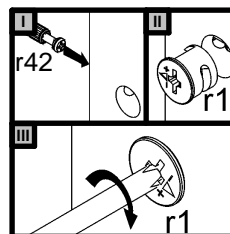
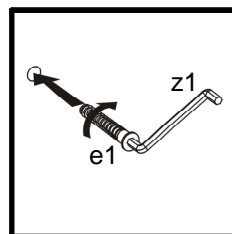
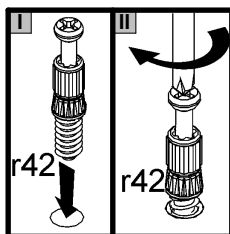
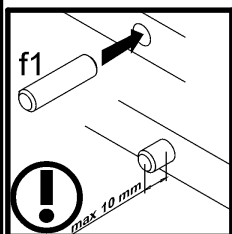
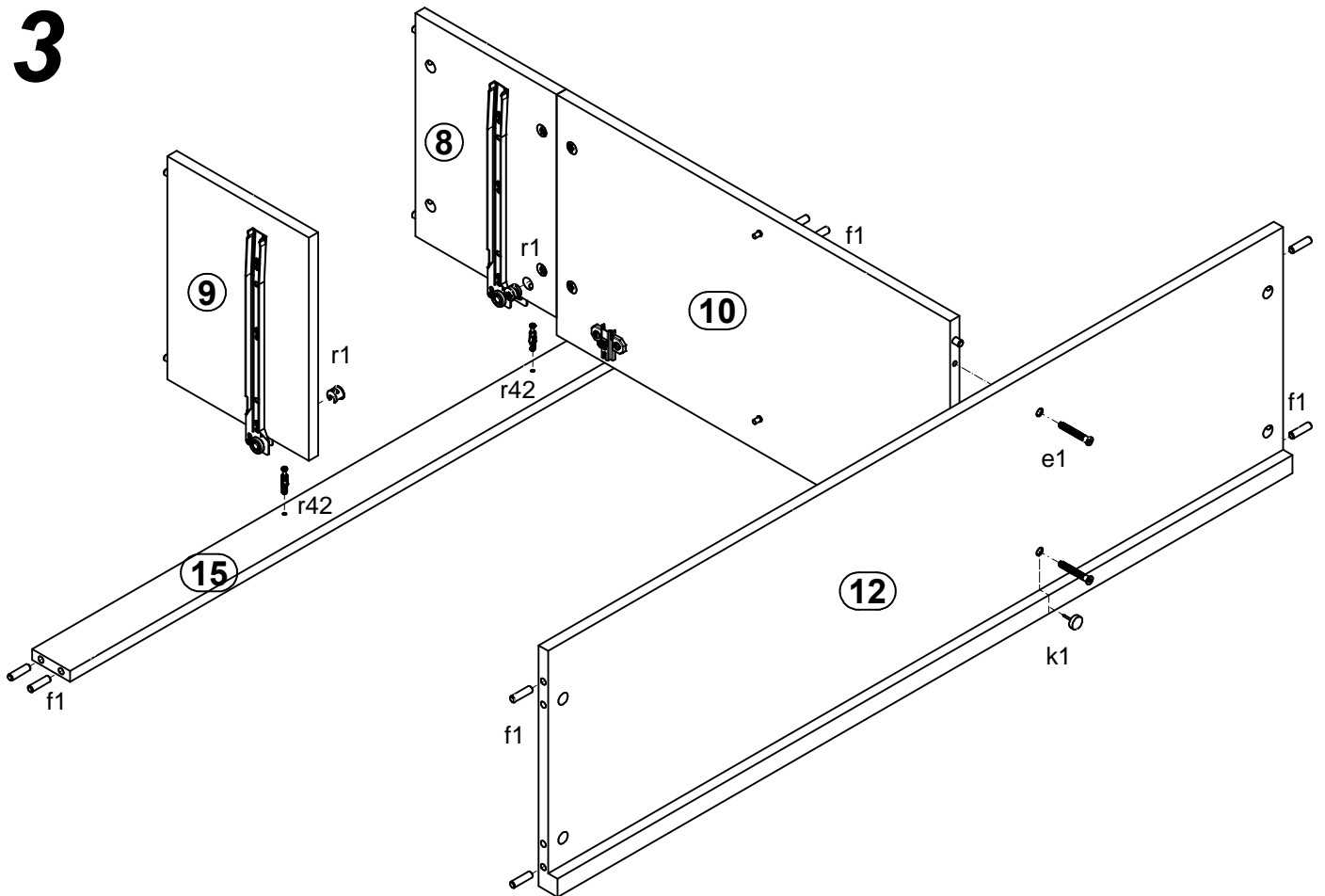

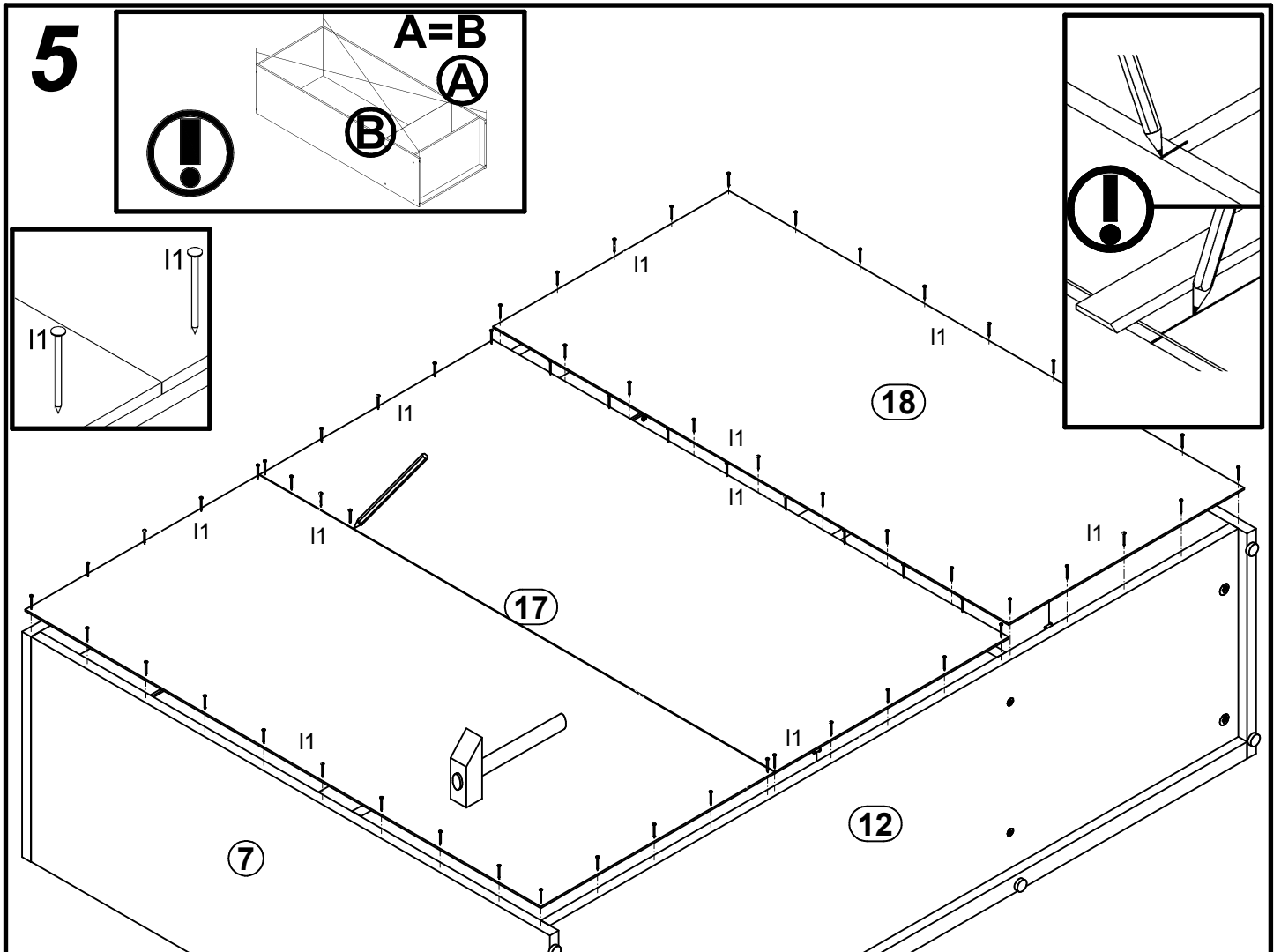
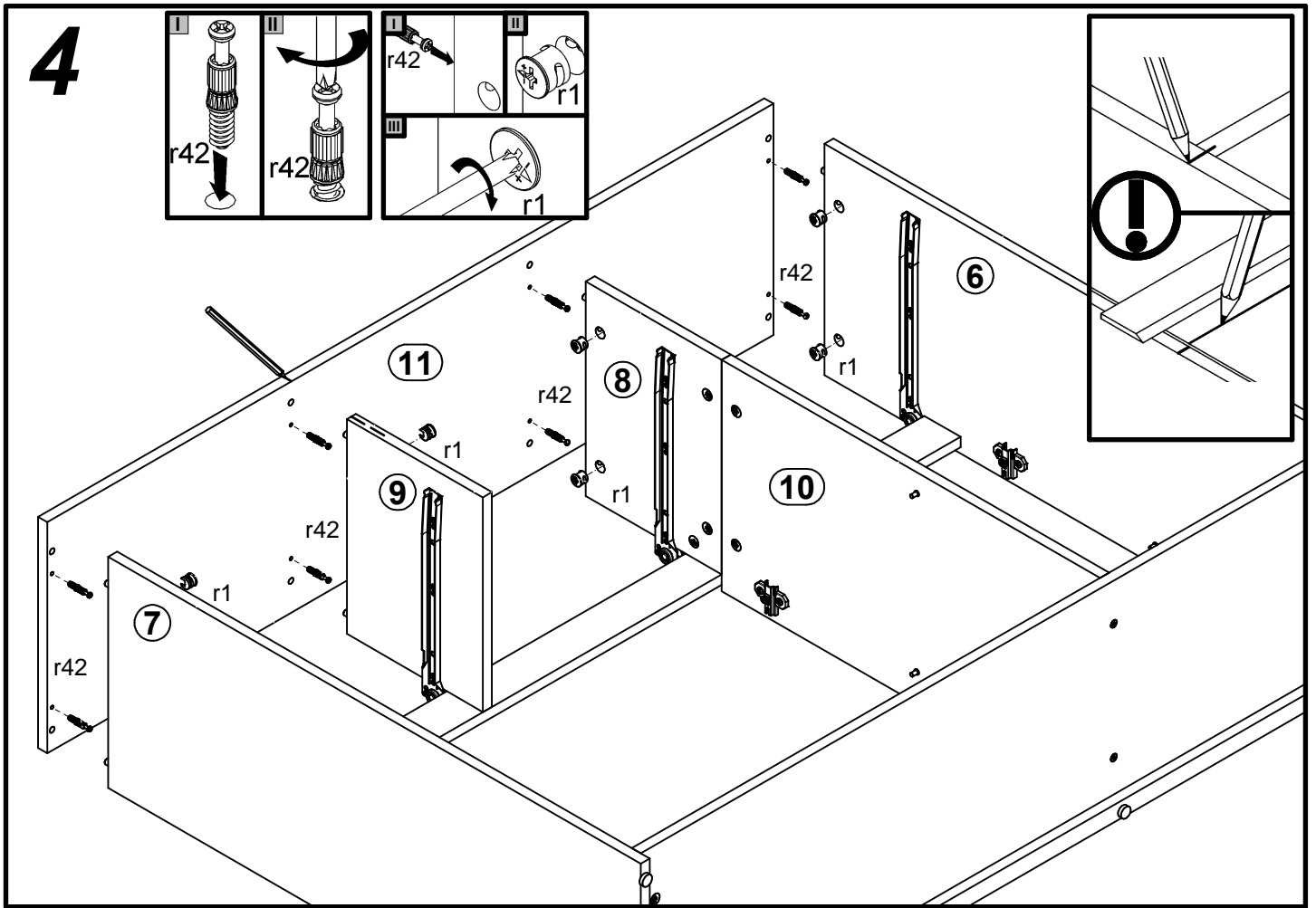

6

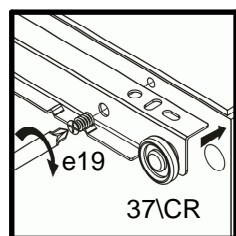
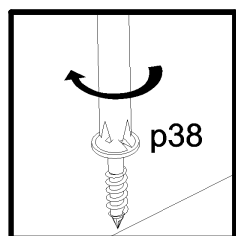
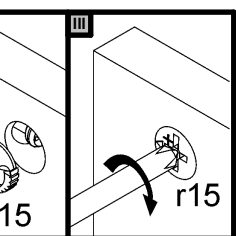
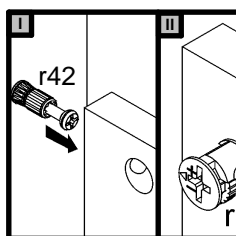
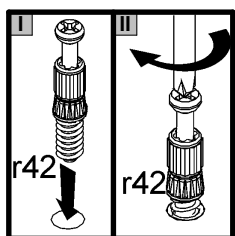
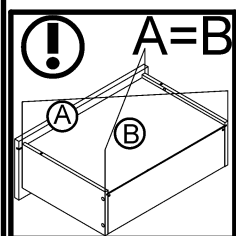
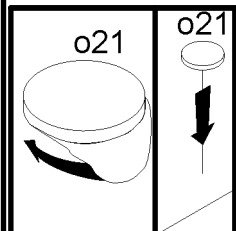
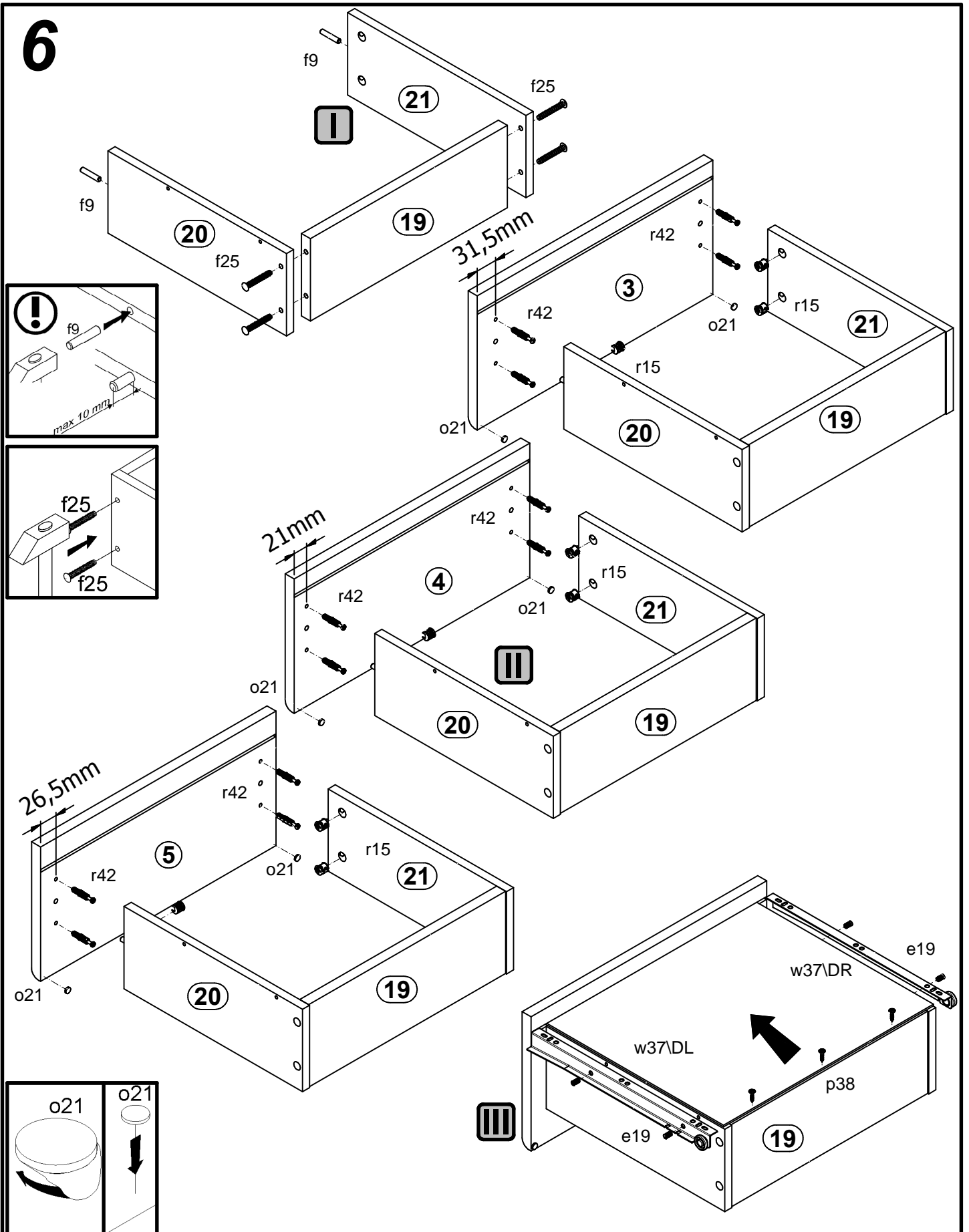

7

