

Montážní návod

Hory B

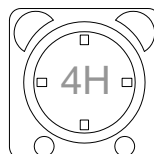

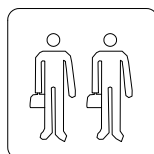

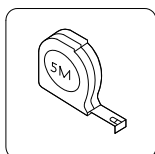
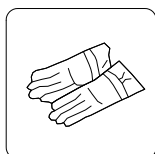
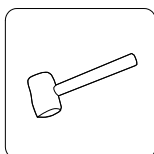
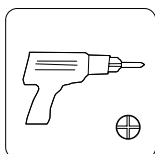
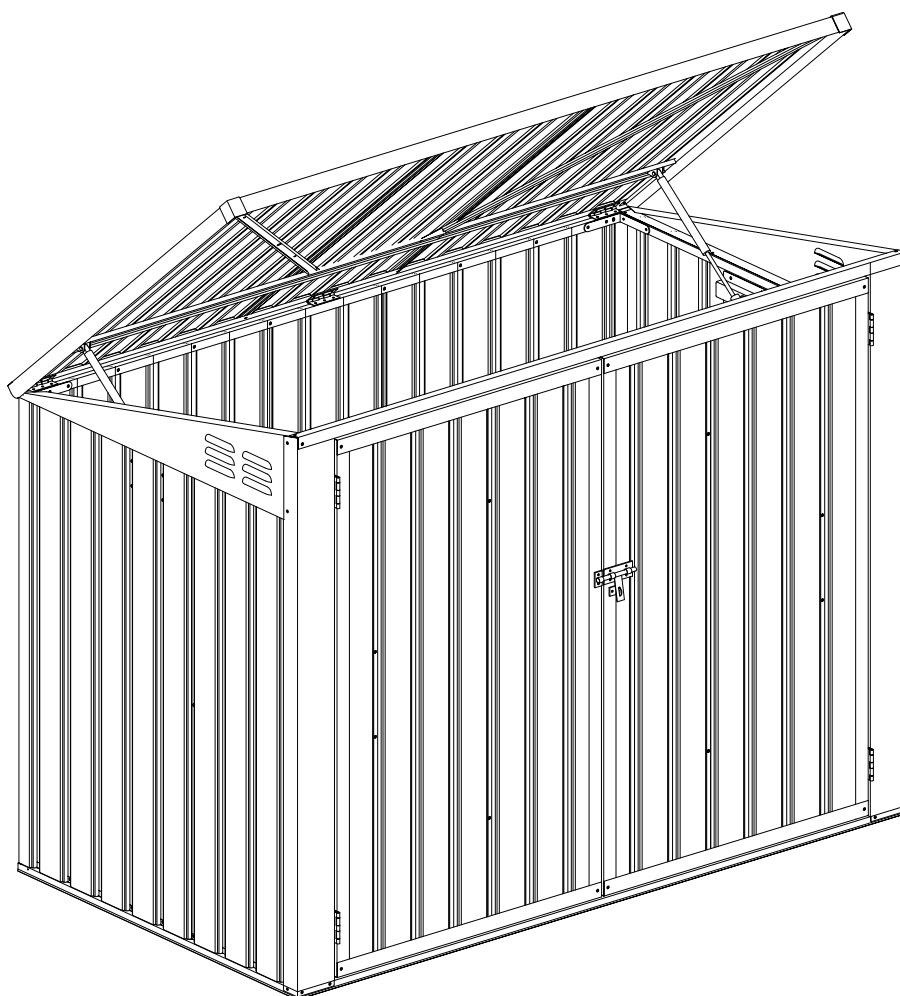
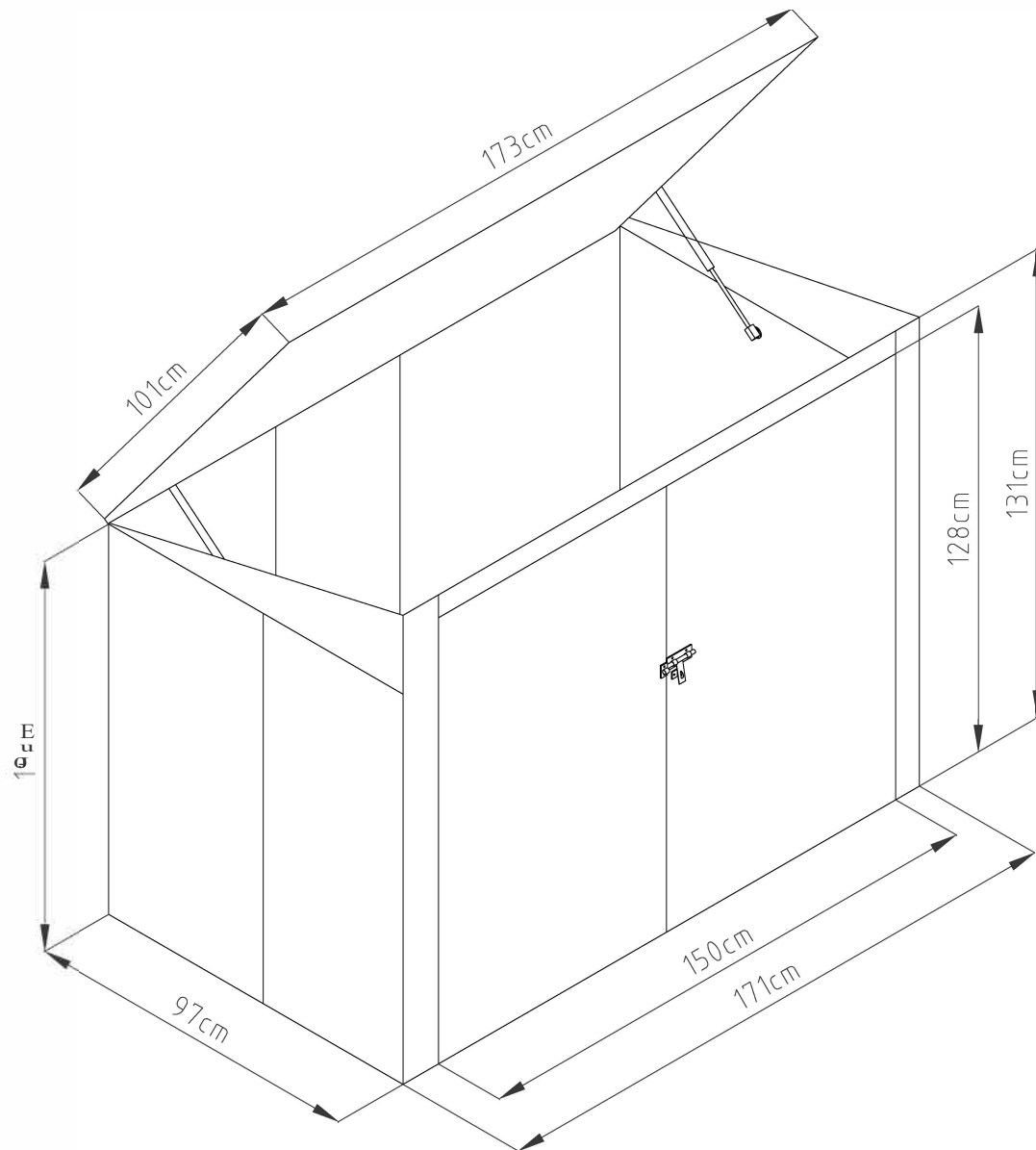

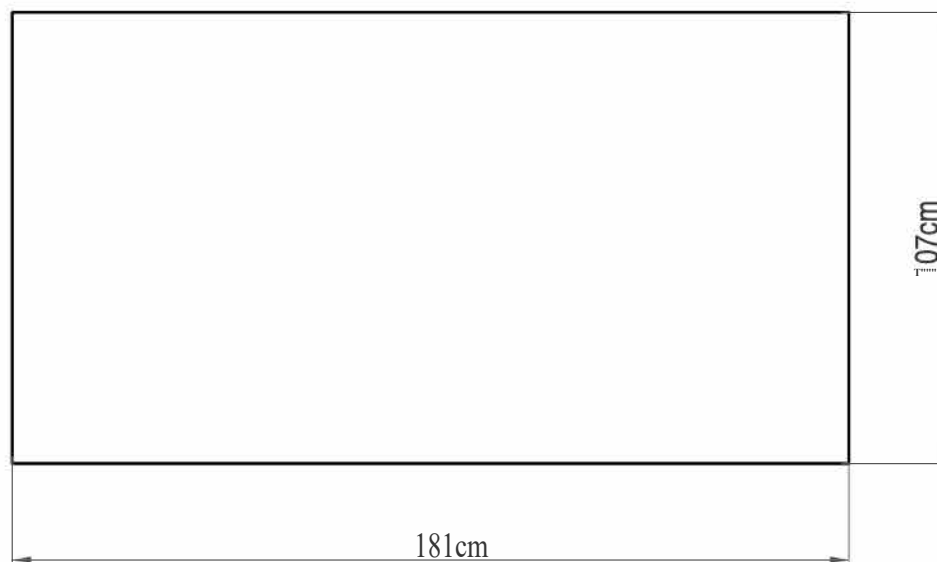

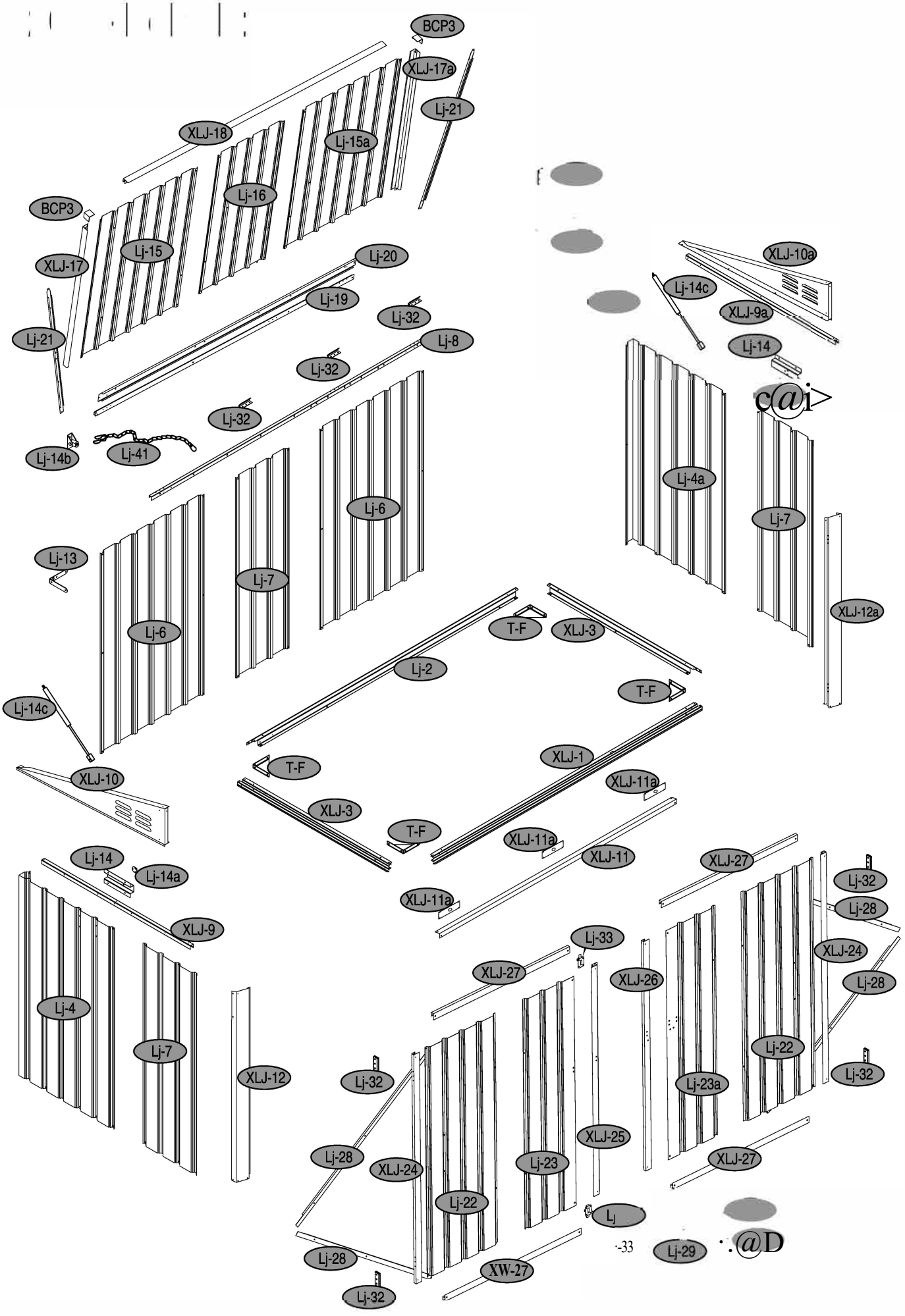

Potřebná montážní plocha:



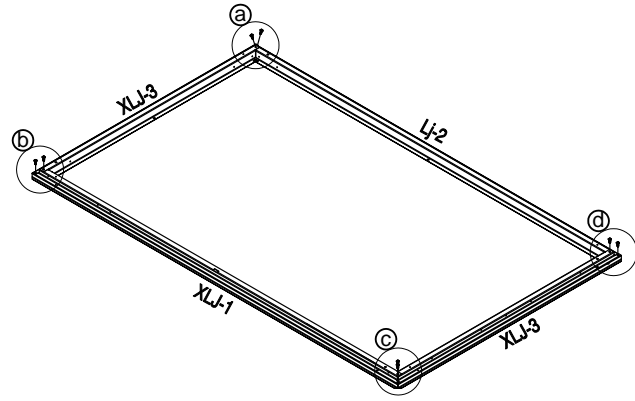
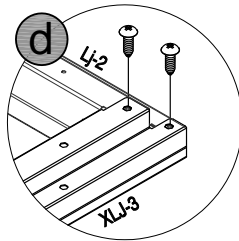
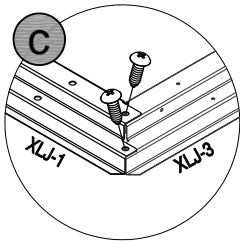
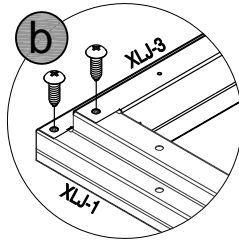
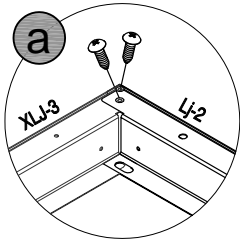

1	 XLJ-1 [x1]	 Lj-2 [x1]	 XLJ-3 [x2]	 Lj-35 [x8]	
---	---	--	---	--	--





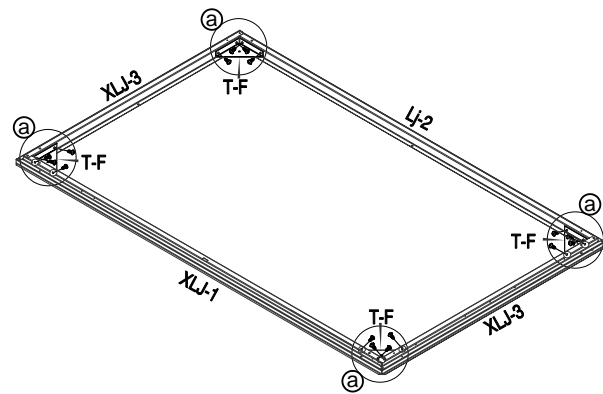
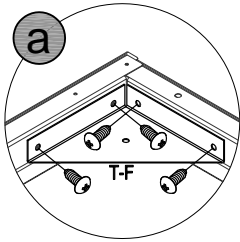

2	 T-F [x4]	 Lj-35 [x16]	
---	---	--	--

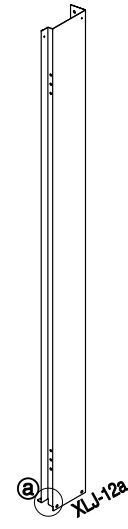
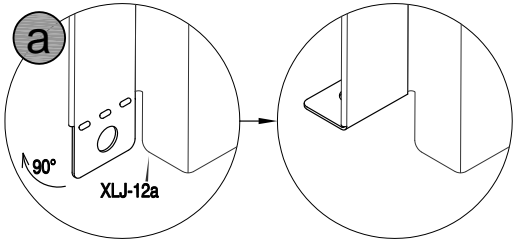

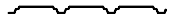

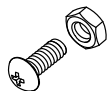

3				
	XLJ-12a [x1]			

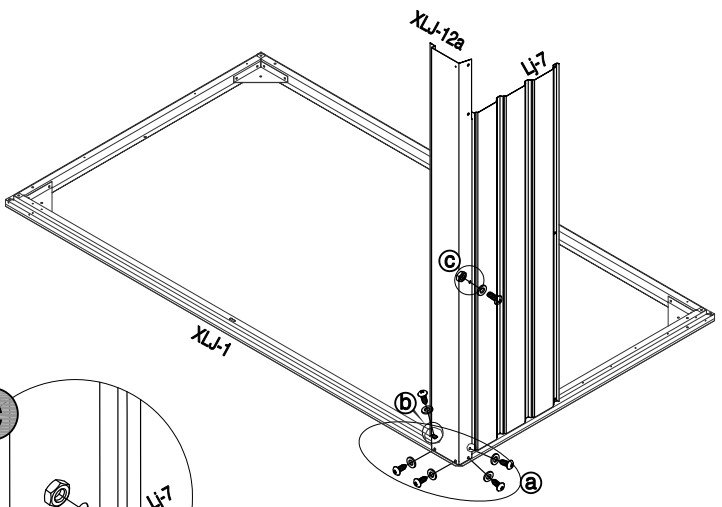
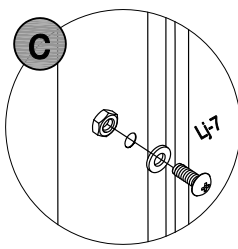
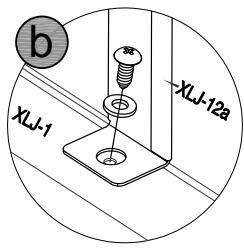
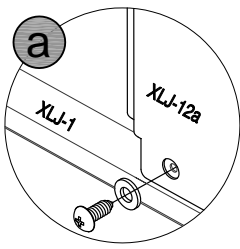
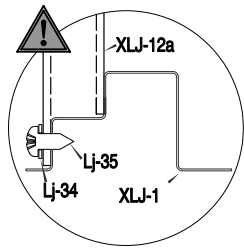
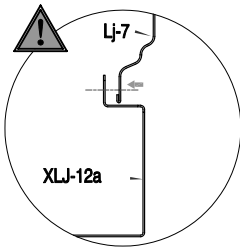

4					
	Lj-7 [x1]	Lj-35 [x5]	Lj-36 [x1]	Lj-34 [x6]	





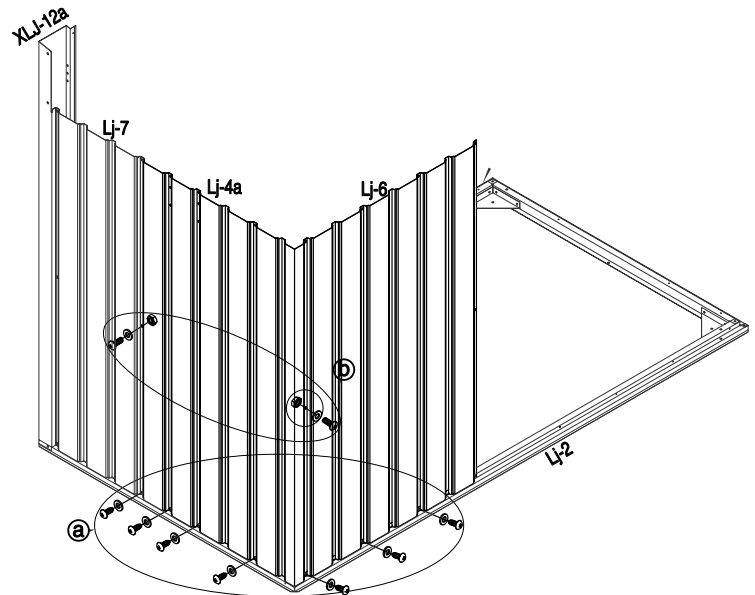
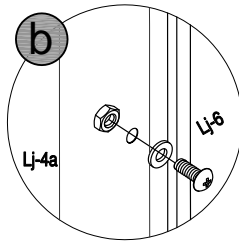
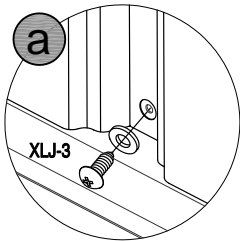
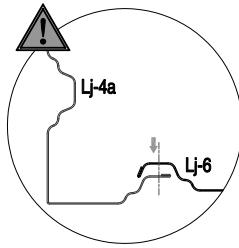
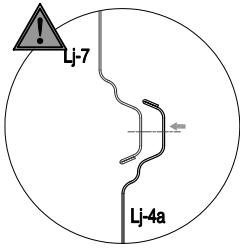

5	 Lj-4a [x1]	 Lj-6 [x1]	 Lj-35 [x7]	 Lj-36 [x2]	 Lj-34 [x9]	
---	---	--	---	--	---	--

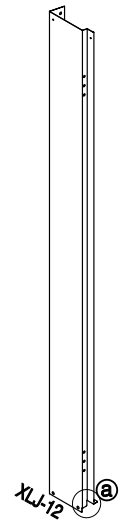
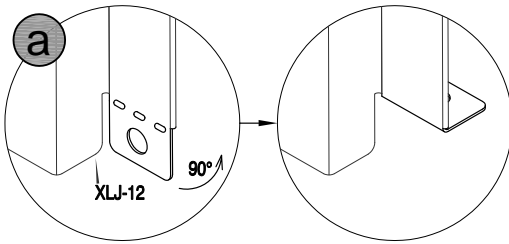

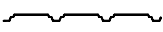



6	 XLJ-12 [x1]	
---	--	--

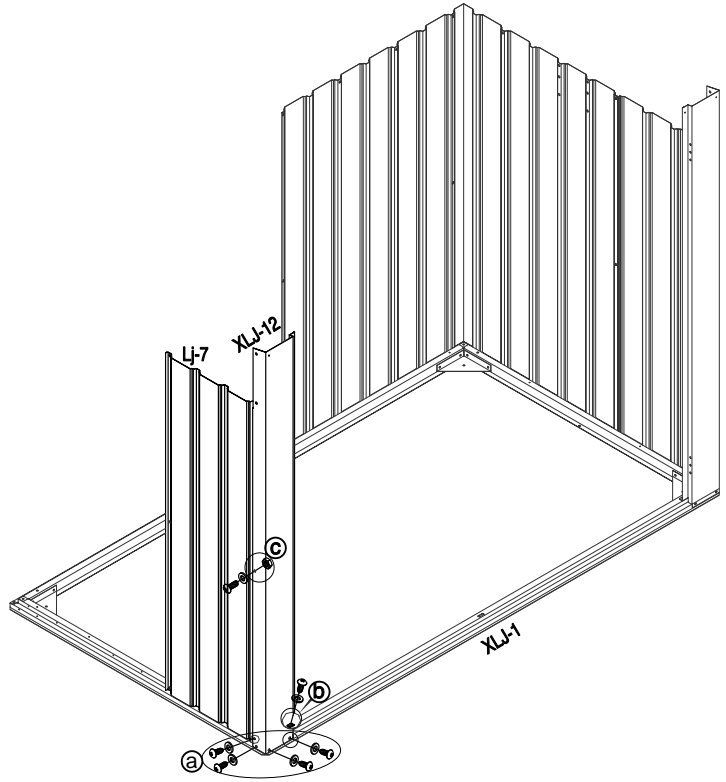
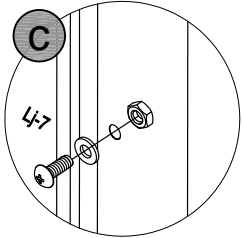
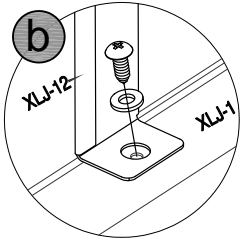
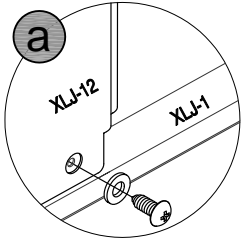
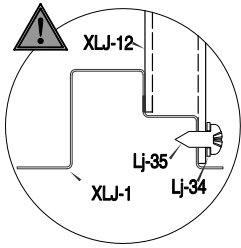
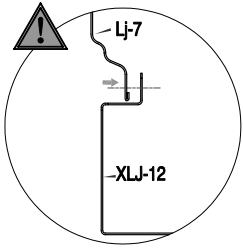





7	 Lj-7 [x1]	 Lj-35 [x5]	 Lj-36 [x1]	 Lj-34 [x6]	
---	--	---	---	--	--

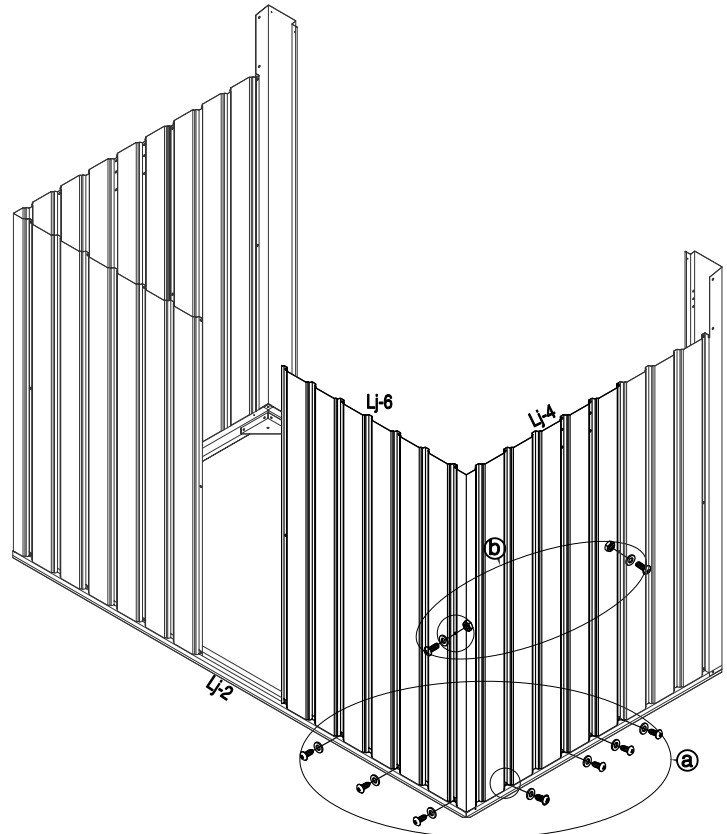
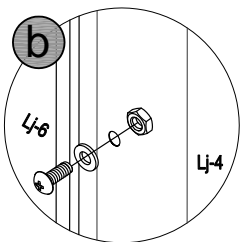
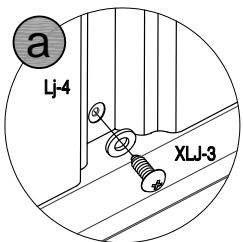
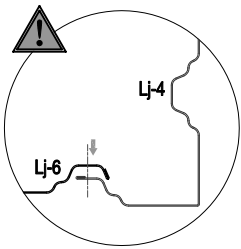
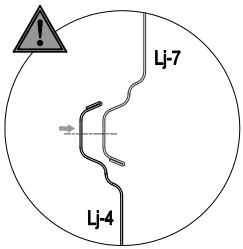



8	 Lj-4 [x1]	 Lj-6 [x1]	 Lj-35 [x7]	 Lj-36 [x2]	 Lj-34 [x9]
---	--	--	---	--	---



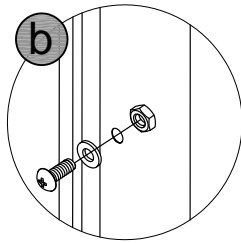
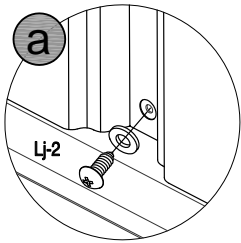
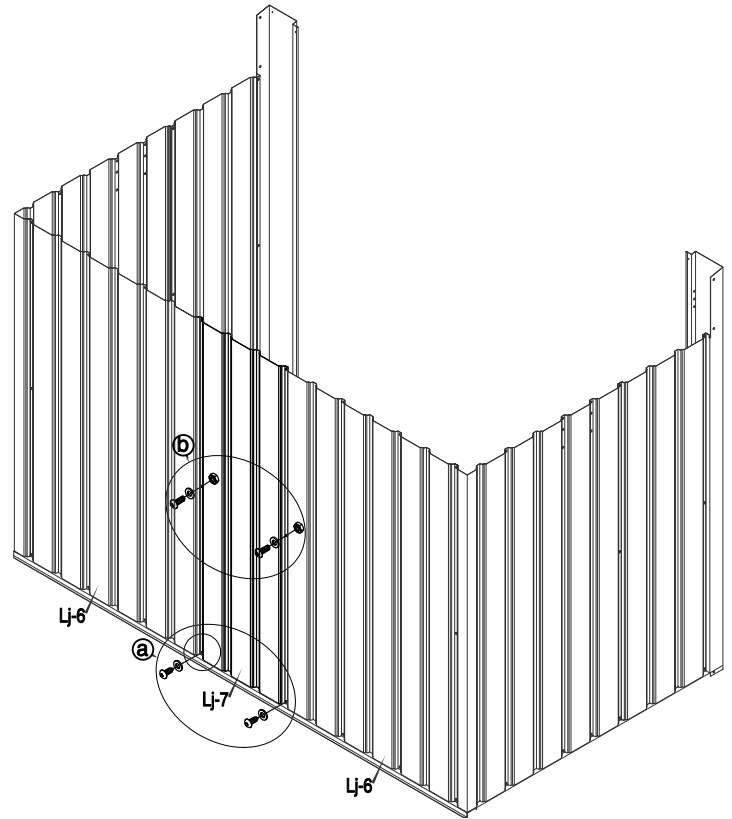
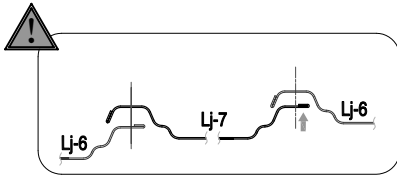



9	 Lj-7 [x1]	 Lj-35 [x2]	 Lj-36 [x2]	 Lj-34 [x4]	
---	--	---	---	--	--

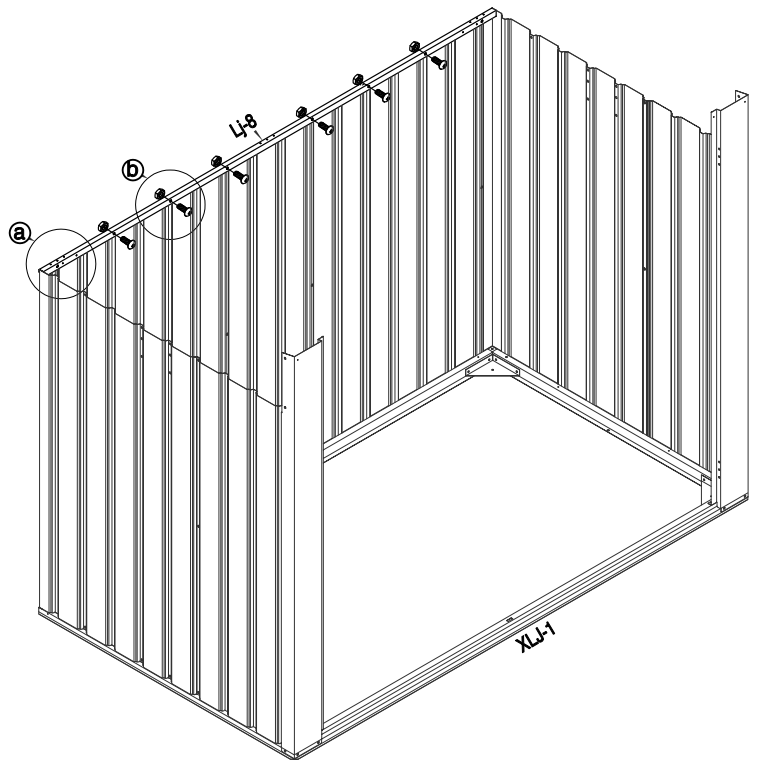
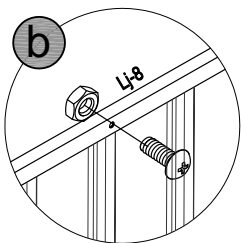
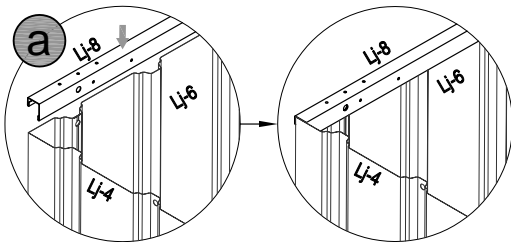
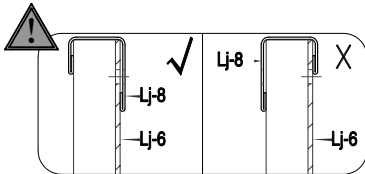



10	 Lj-8 [x1]	 Lj-36 [x6]	
----	--	---	--



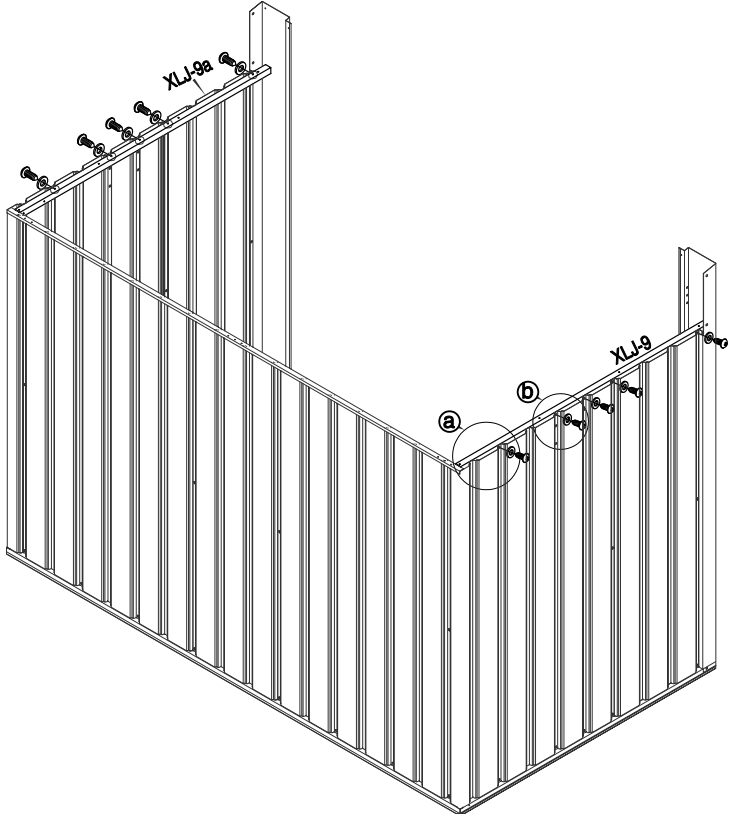
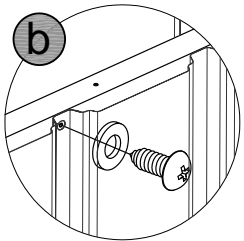
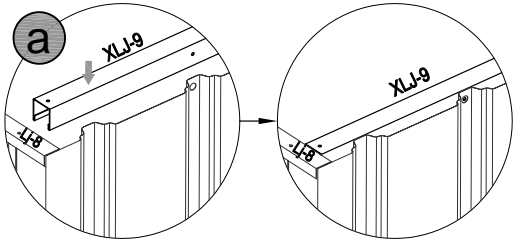

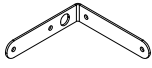

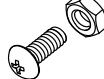
<p>11</p>	 <p>XLJ-9 [x1]</p>	 <p>XLJ-9a [x1]</p>	 <p>Lj-35 [x10]</p>	 <p>Lj-34 [x10]</p>	
------------------	---	--	--	---	--

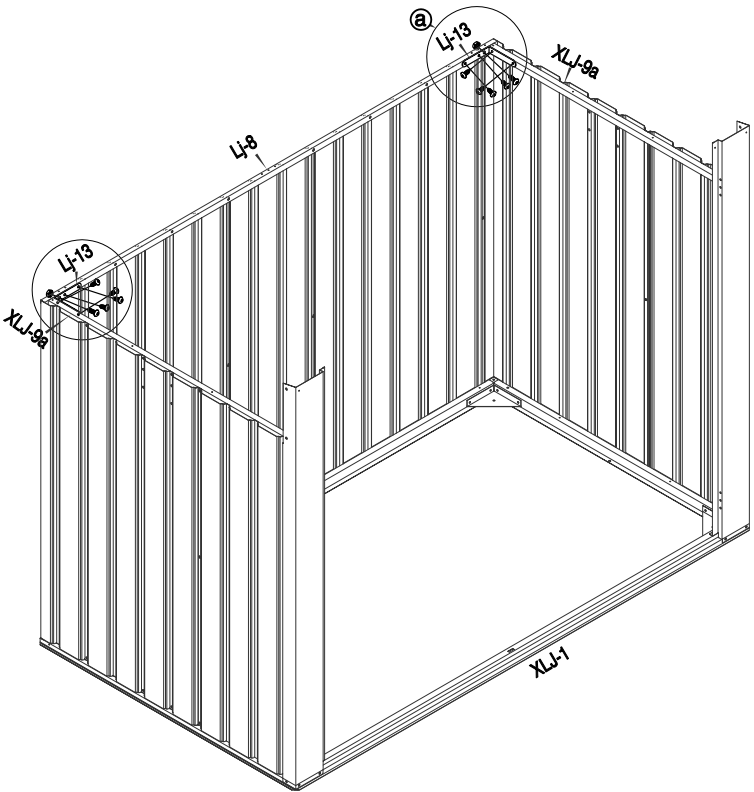
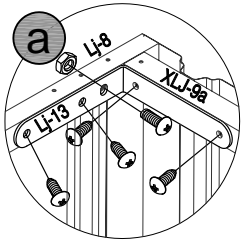

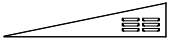
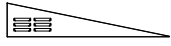

<p>12</p>	 <p>Lj-13 [x2]</p>	 <p>Lj-35 [x8]</p>	 <p>Lj-36 [x2]</p>	
------------------	---	---	---	--

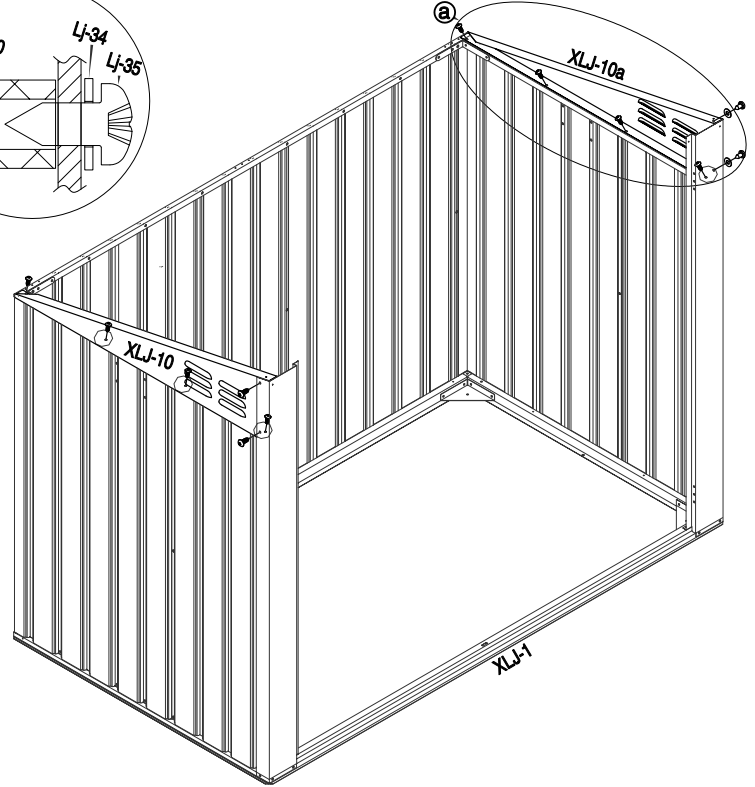
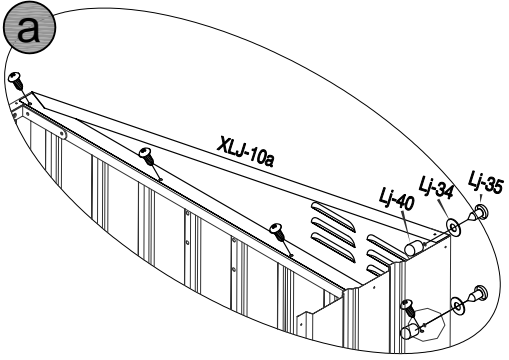
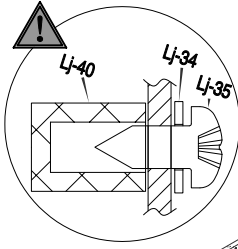
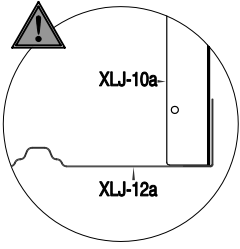
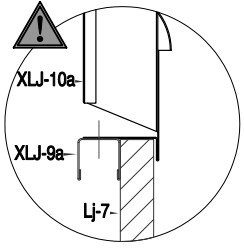

<p>13</p>	 <p>XLJ-10 [x1]</p>	 <p>XLJ-10a [x1]</p>	 <p>Lj-35 [x12]</p>	 <p>Lj-34 [x4]</p>	 <p>Lj-40 [x4]</p>	
------------------	--	---	--	--	---	--



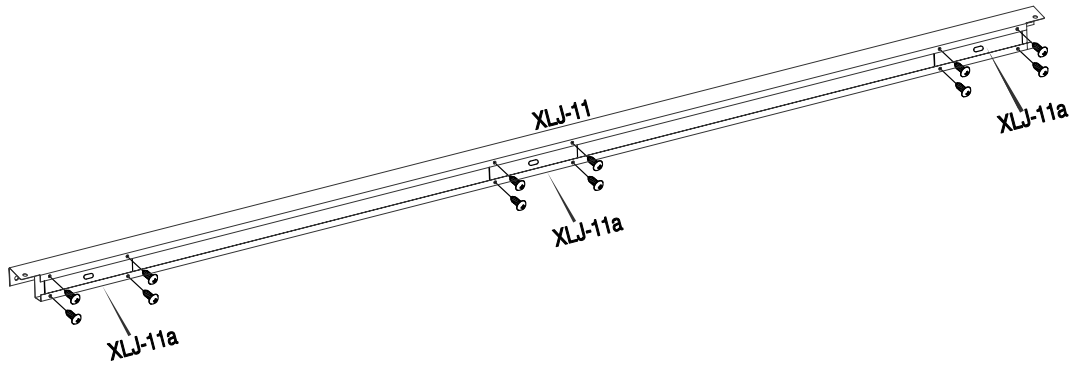
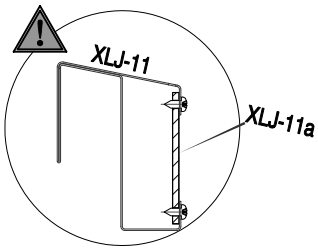

<p>14</p>	 <p>XLJ-11 [x1]</p>	 <p>XLJ-11a [x3]</p>	 <p>Lj-35 [x12]</p>	
------------------	--	---	--	--



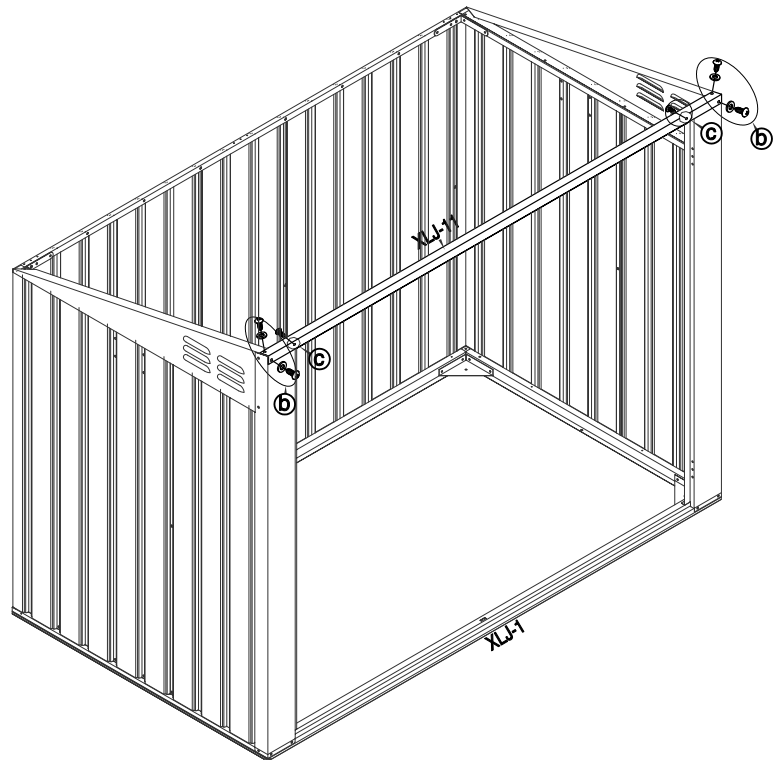
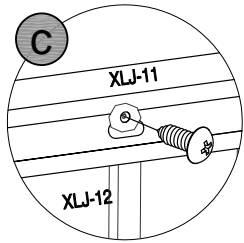
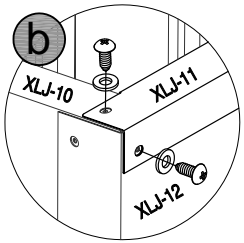
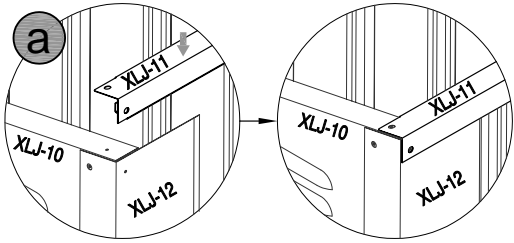

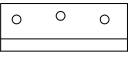
<p>15</p>	 <p>Lj-35 [x6]</p>	 <p>Lj-34 [x4]</p>	
------------------	---	---	--



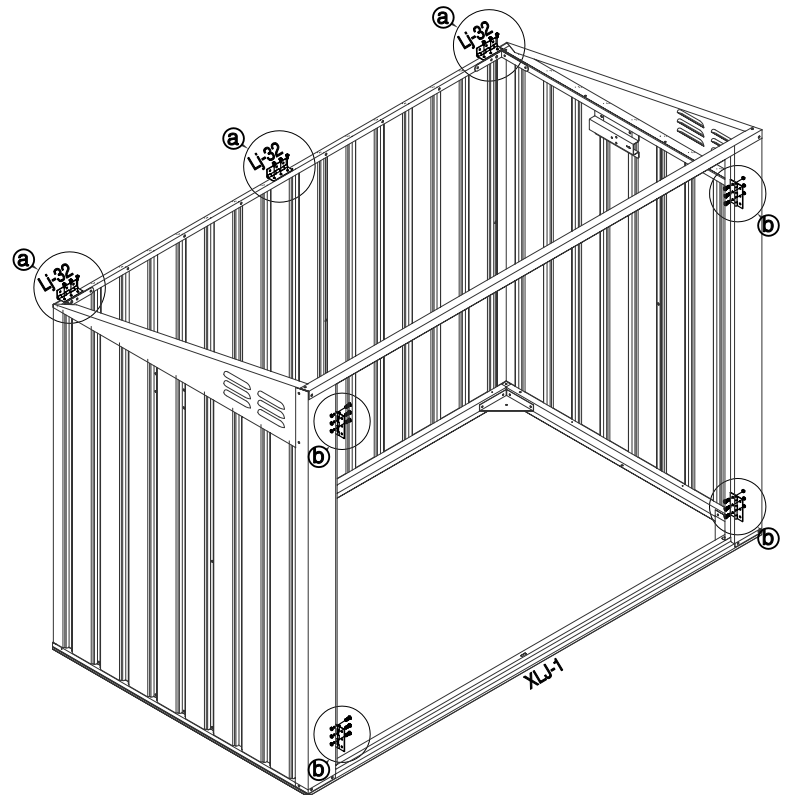
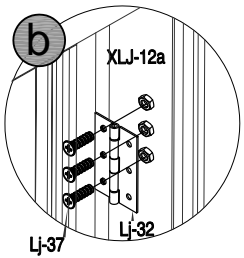
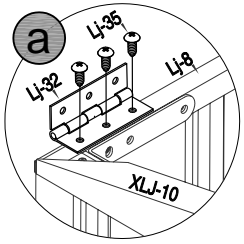

<p>16</p>	 <p>Lj-32 [x7]</p>	 <p>Lj-35 [x9]</p>	 <p>Lj-37 [x12]</p>
------------------	---	---	--

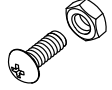

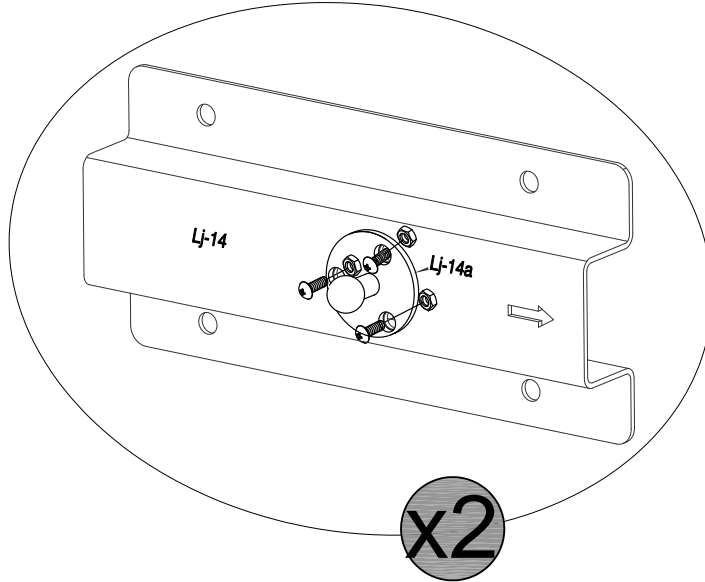
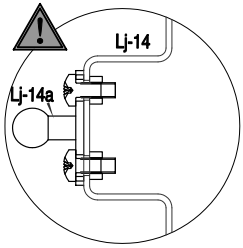

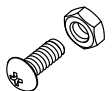

<p>17</p>	 <p>Lj-14 [x2]</p>	 <p>Lj-14a [x2]</p>	 <p>Lj-36 [x6]</p>	
-----------	---	--	---	--

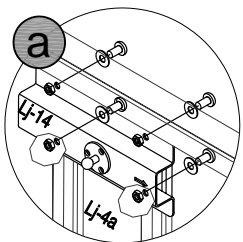
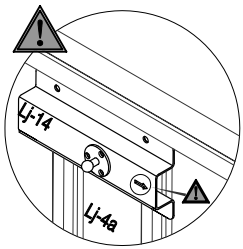

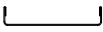
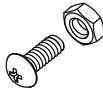

<p>18</p>	 <p>Lj-36 [x8]</p>	 <p>Lj-34 [x8]</p>	
-----------	---	---	--



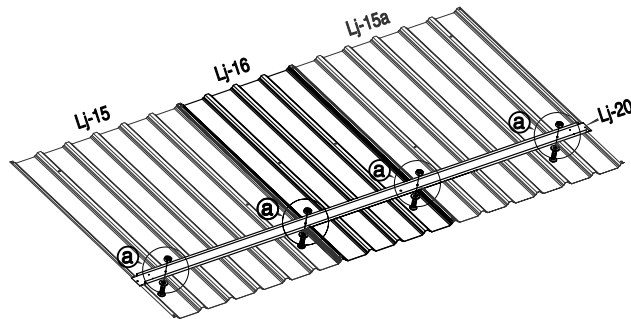
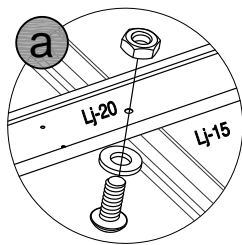
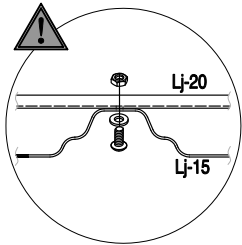
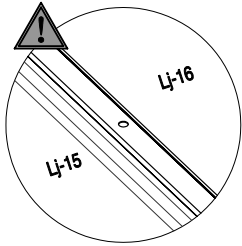
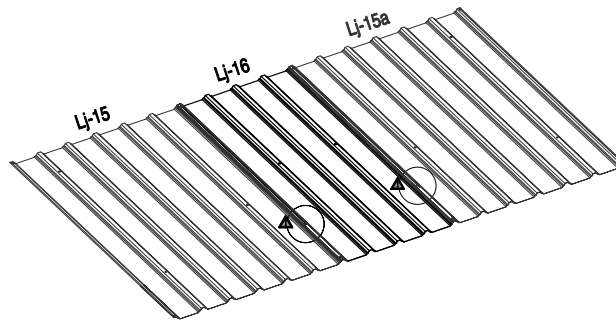
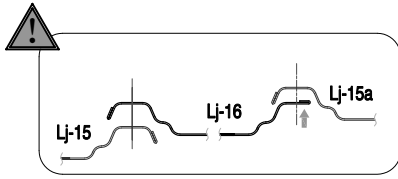



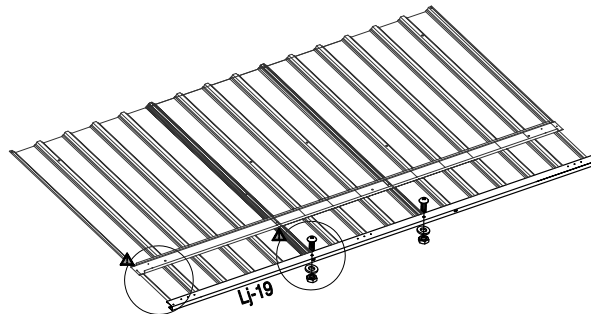
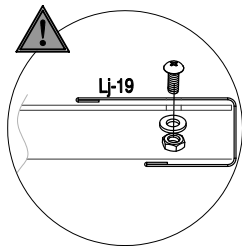
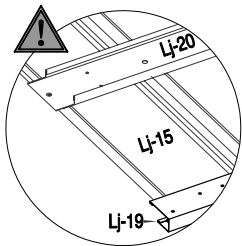

19	 Lj-15 [x1]	 Lj-15a [x1]	 Lj-16 [x1]	 Lj-20 [x1]	 Lj-36 [x4]	 Lj-34 [x4]
----	---	--	---	--	---	---







20	 Lj-19 [x1]	 Lj-36 [x2]	 Lj-34 [x2]	
----	---	---	---	--

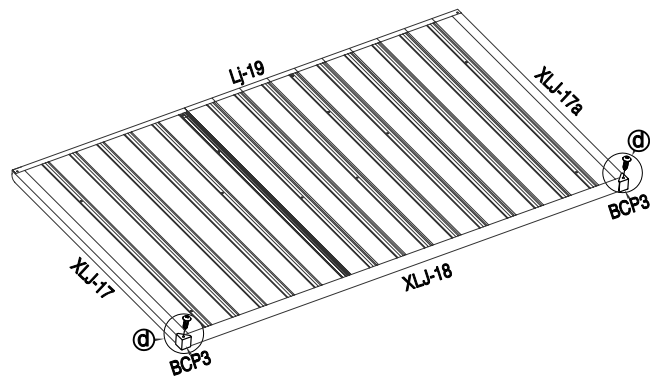
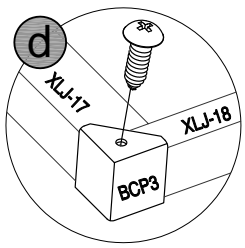
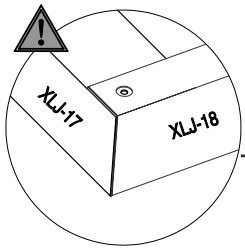
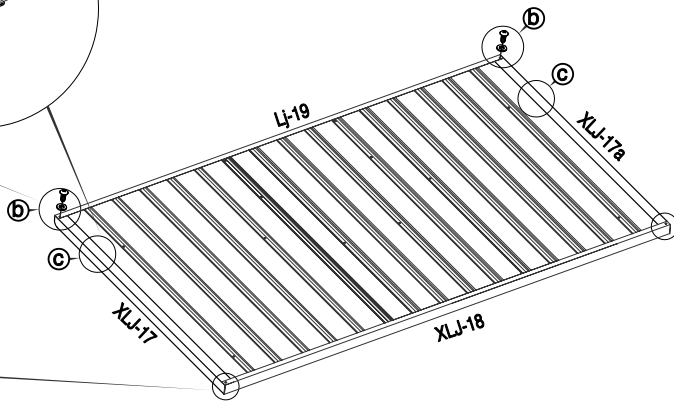
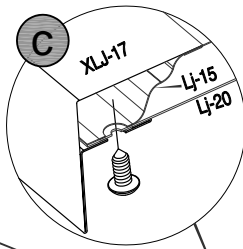
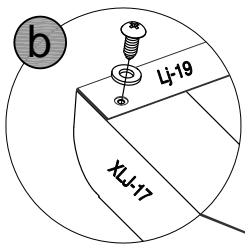
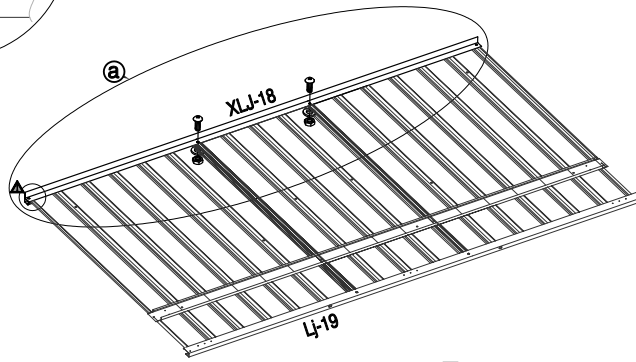
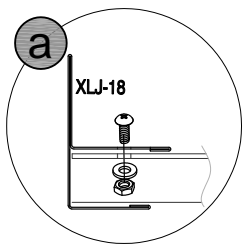
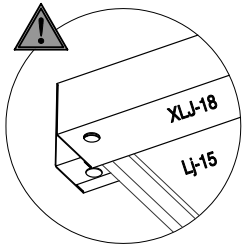

21	 XLJ-18 [x1]	 XLJ-17 [x1]	 XLJ-17a [x1]	 BCP3 [x2]	 Lj-36 [x2]	 Lj-35 [x6]
						 Lj-34 [x4]



	 Lj-21 [x2]	 Lj-14b [x2]	 Lj-35 [x8]	 Lj-36 [x4]	
--	---	--	---	--	--

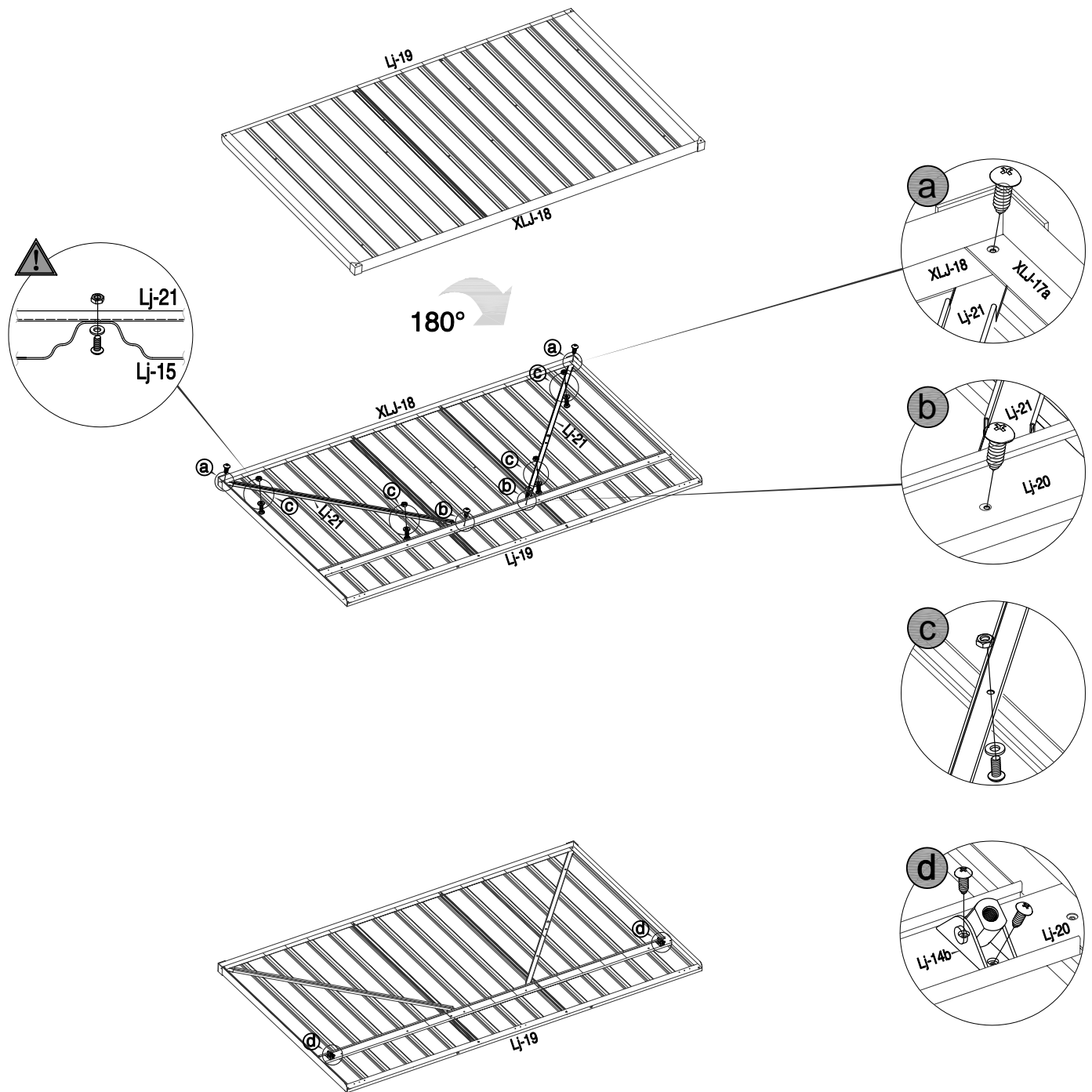

23



Lj-35 [x9]

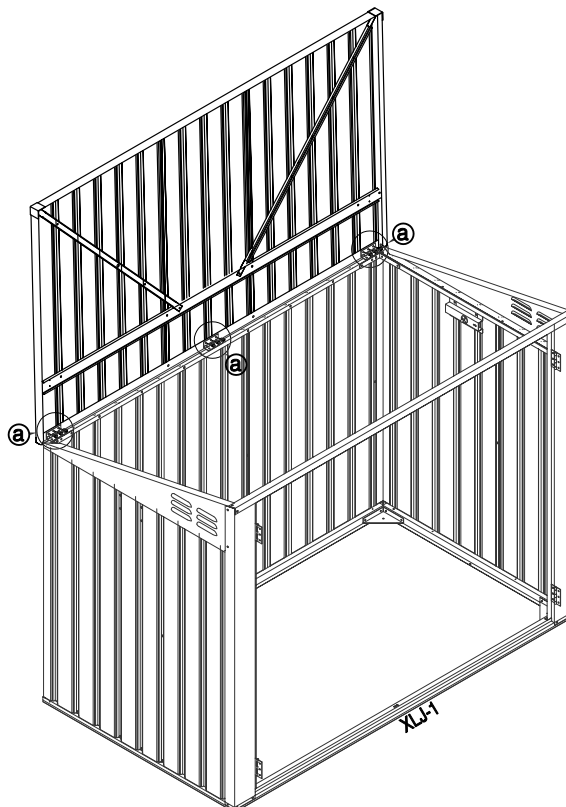
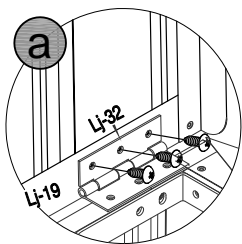



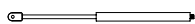

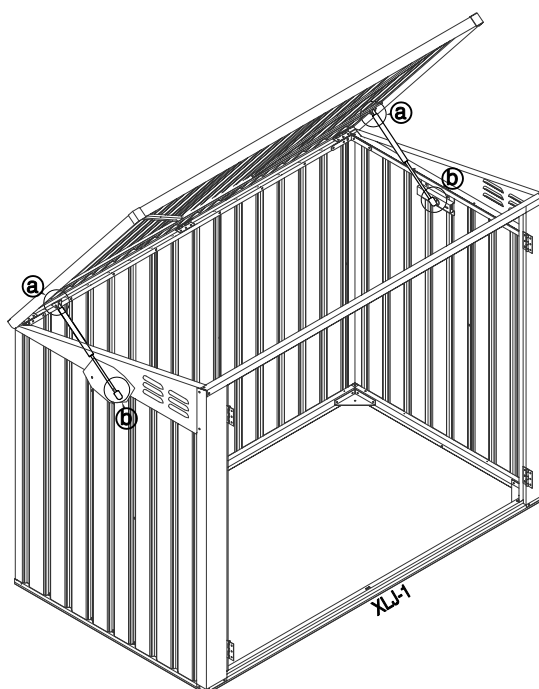
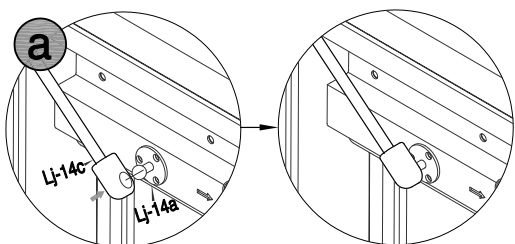
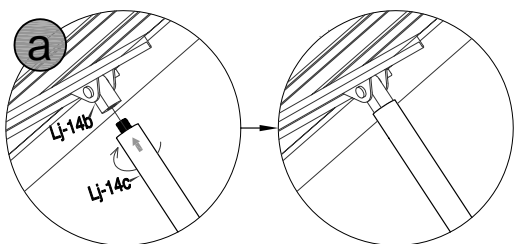

24



Lj-14c [x2]





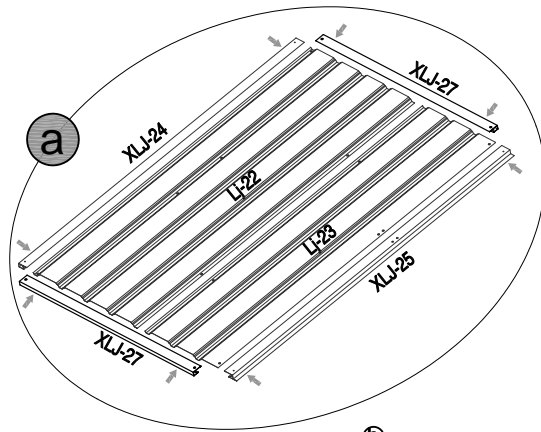
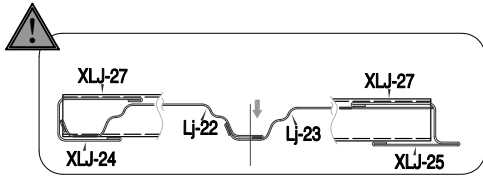

25	 Lj-22 [x1]	 Lj-23 [x1]	 XLJ-27 [x2]	 XLJ-24 [x1]	 XLJ-25 [x1]	 Lj-35 [x4]
-----------	--	--	---	---	---	--

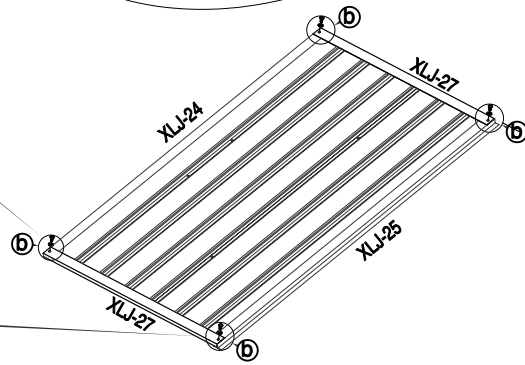
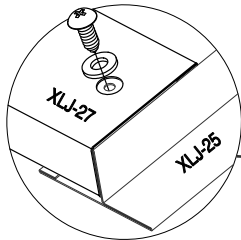
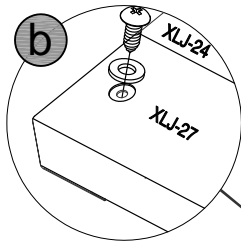

 Lj-34 [x4]
--



26	 Lj-29 [x1]	 Lj-28 [x2]	 Lj-35 [x4]	 Lj-36 [x4]	 Lj-34 [x4]
-----------	--	--	--	---	--

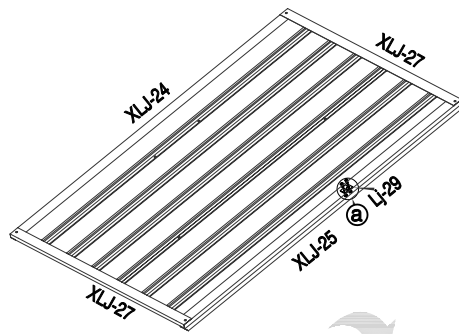
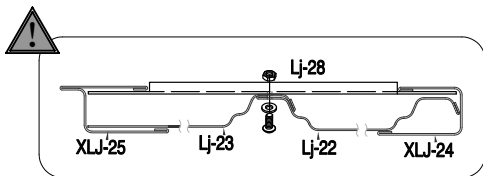
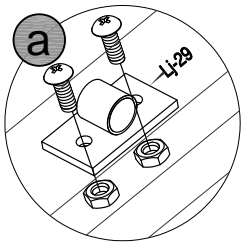



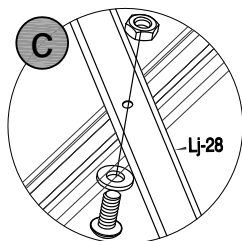
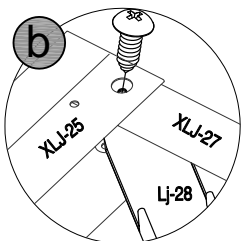
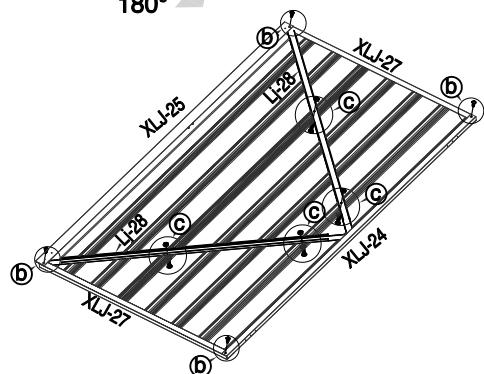

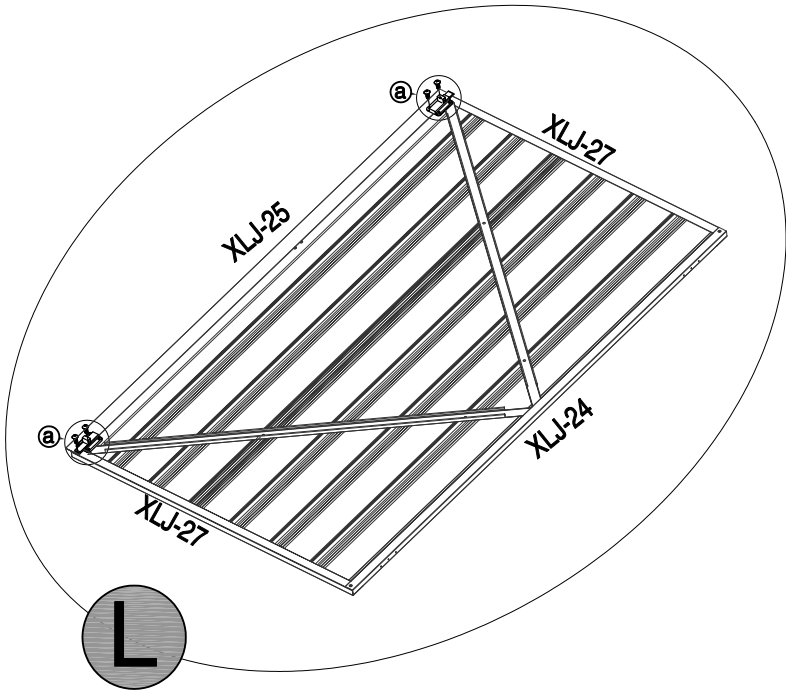
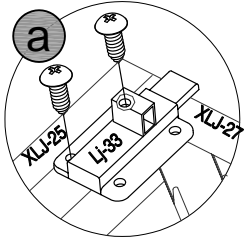

180°



27	 Lj-33 [x2]	 Lj-35 [x4]	
----	---	---	--





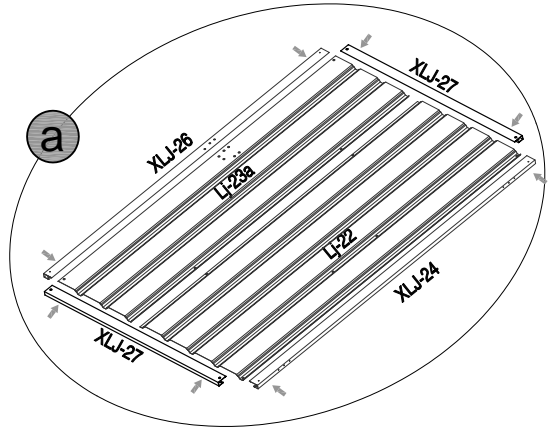
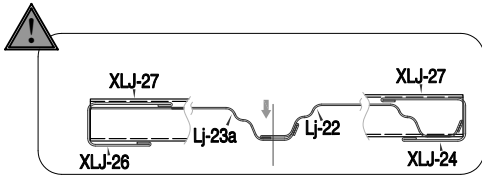

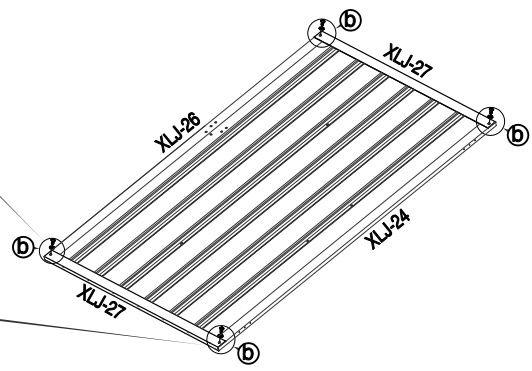
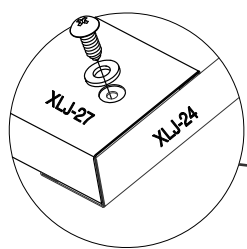
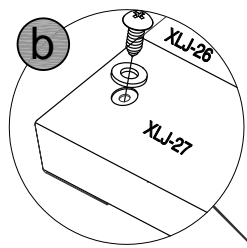

28	 Lj-22 [x1]	 Lj-23a [x1]	 XLJ-27 [x2]	 XLJ-24 [x1]	 XLJ-26 [x1]	 Lj-35 [x4]
----	---	--	--	--	--	---



 Lj-34 [x4]



<p>29</p>	 <p>Lj-30 [x1]</p>	 <p>Lj-31 [x1]</p>	 <p>Lj-28 [x2]</p>	 <p>Lj-35 [x4]</p>	 <p>Lj-36 [x10]</p>	 <p>Lj-34 [x4]</p>
------------------	---	---	---	--	--	---

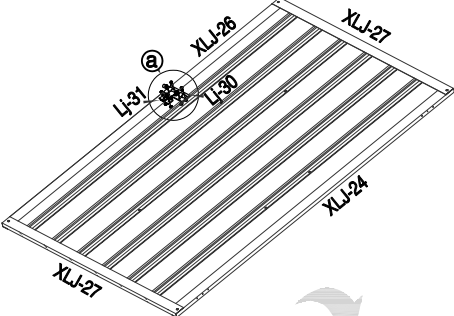
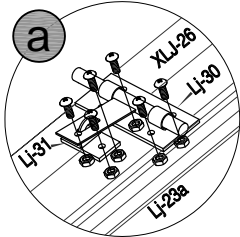

180°

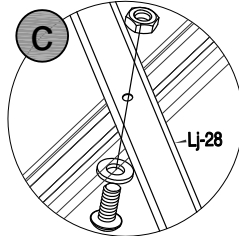
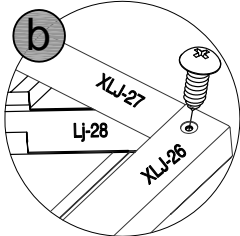
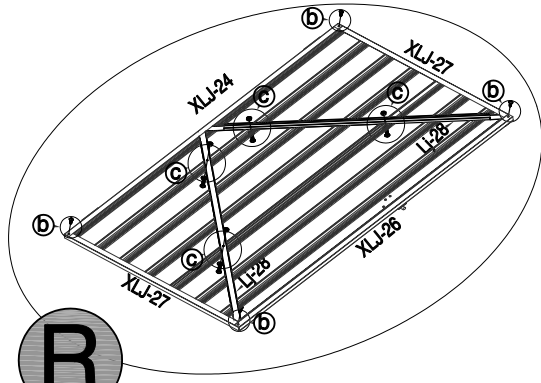
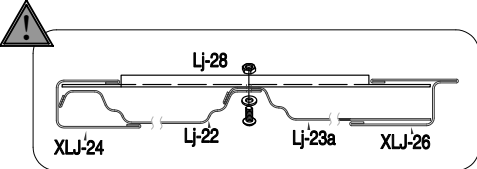

<p>30</p>	 <p>Lj-35 [x6]</p>	
------------------	---	--

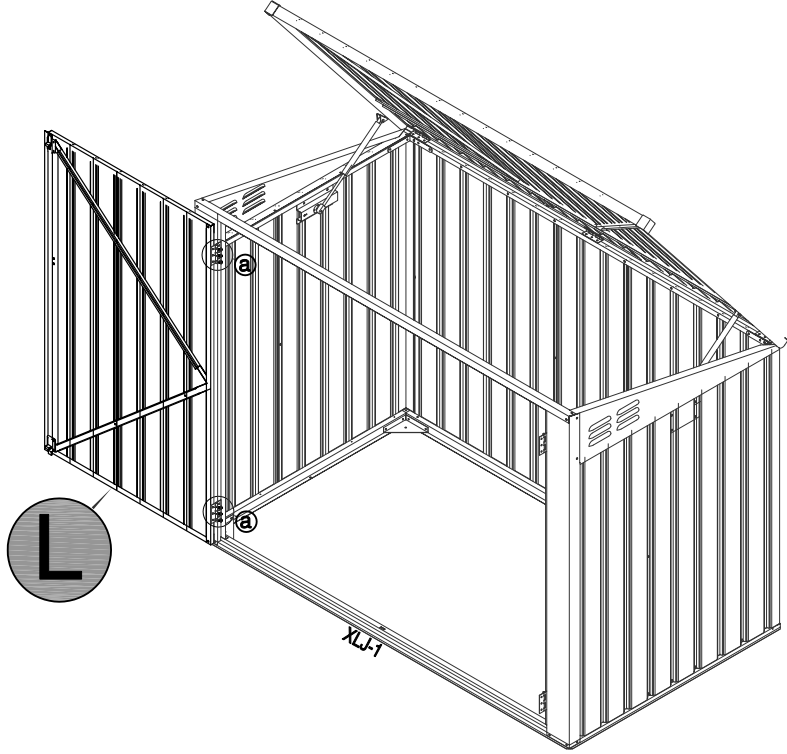
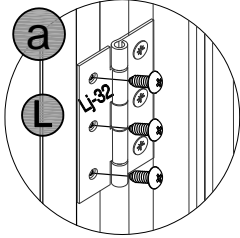

31



Lj-35 [x6]

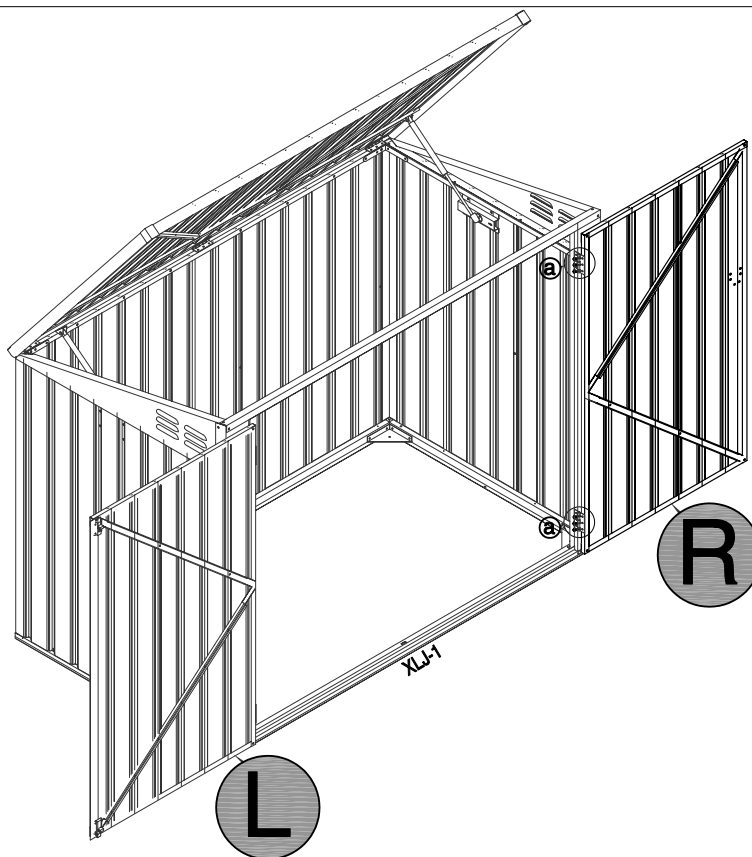
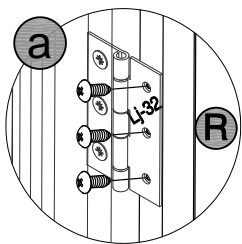

32



Lj-41 [x2]

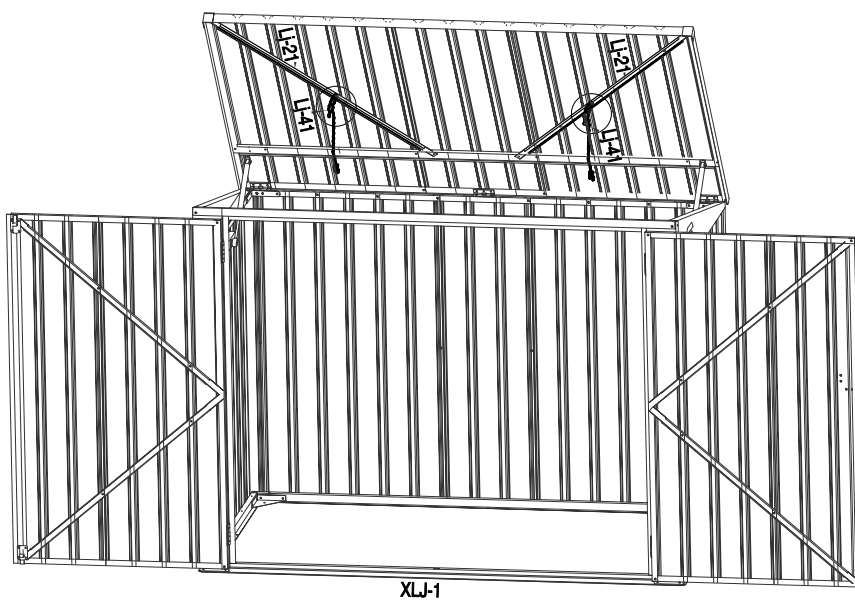
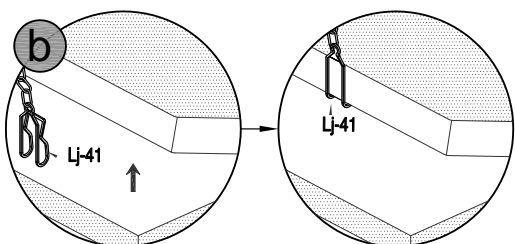
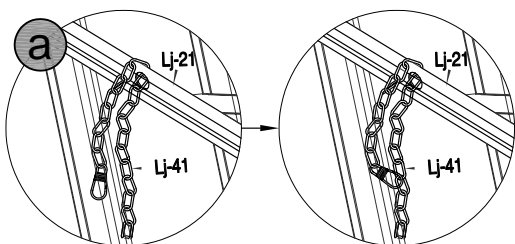

33

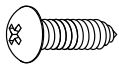

Lj-38 [x8]

