

Návod k montáži Hypnos A

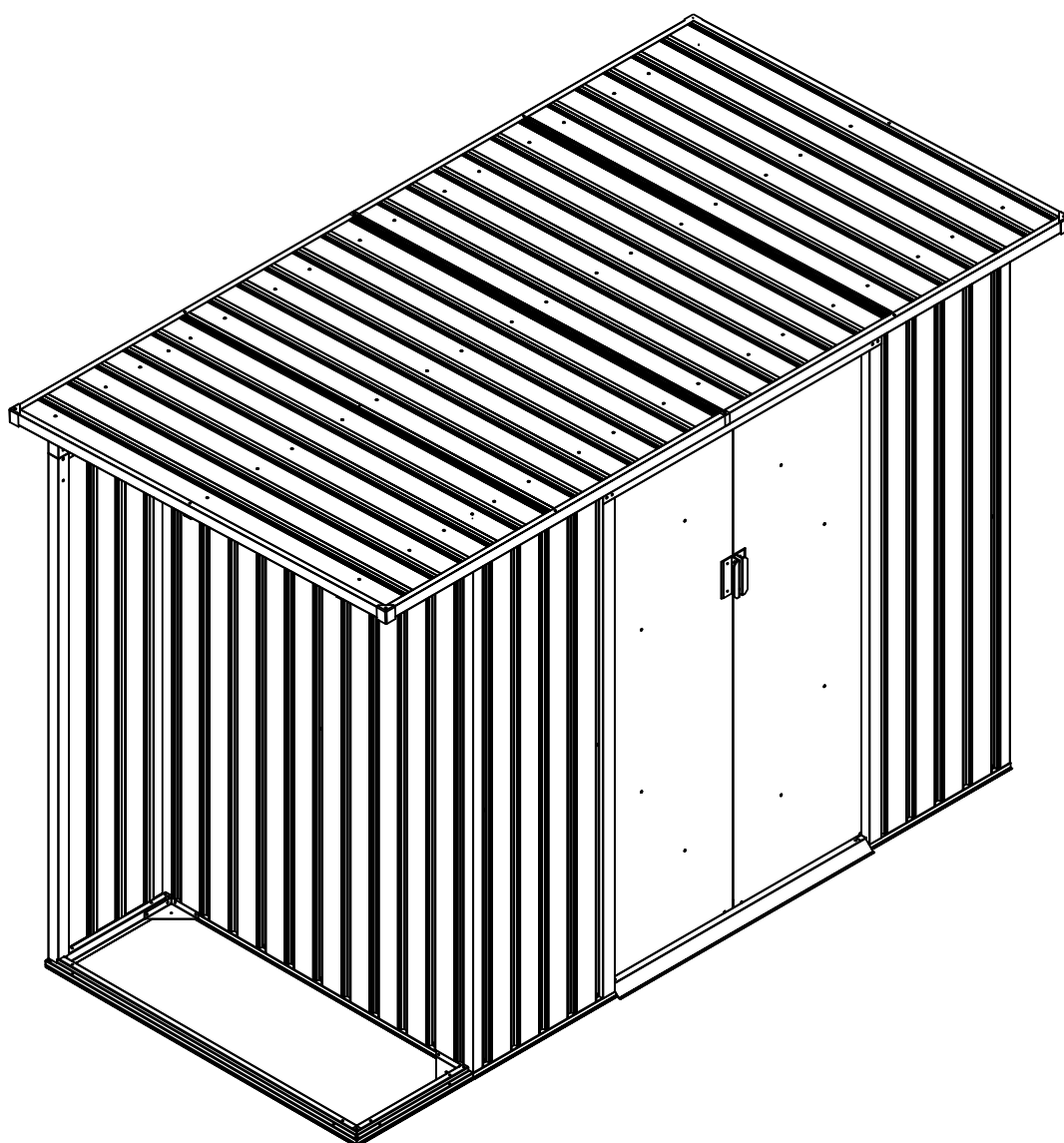

Montáž vyžaduje dvě osoby a trvá cca 3-4 hodiny.

Rozměry:

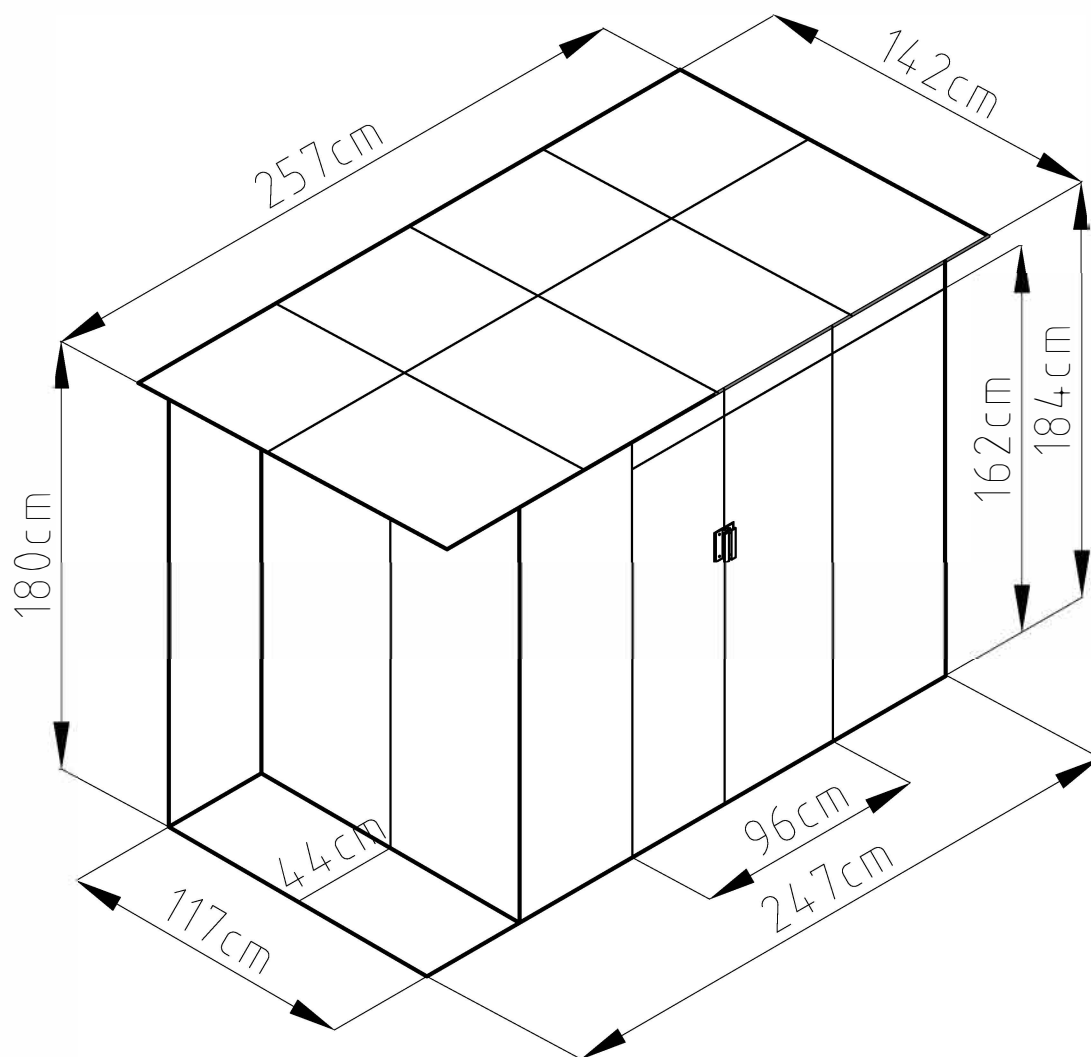

Potřebná montážní plocha:

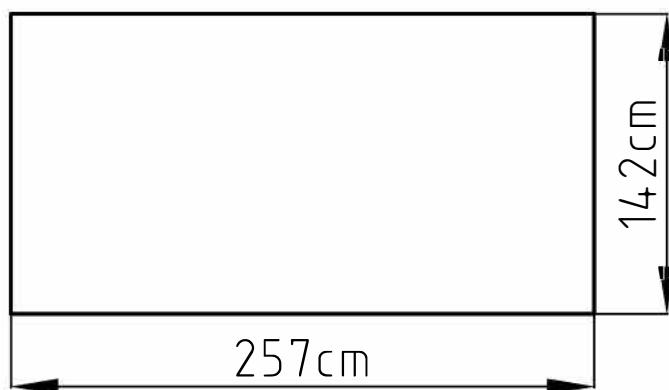

Hypnos A:

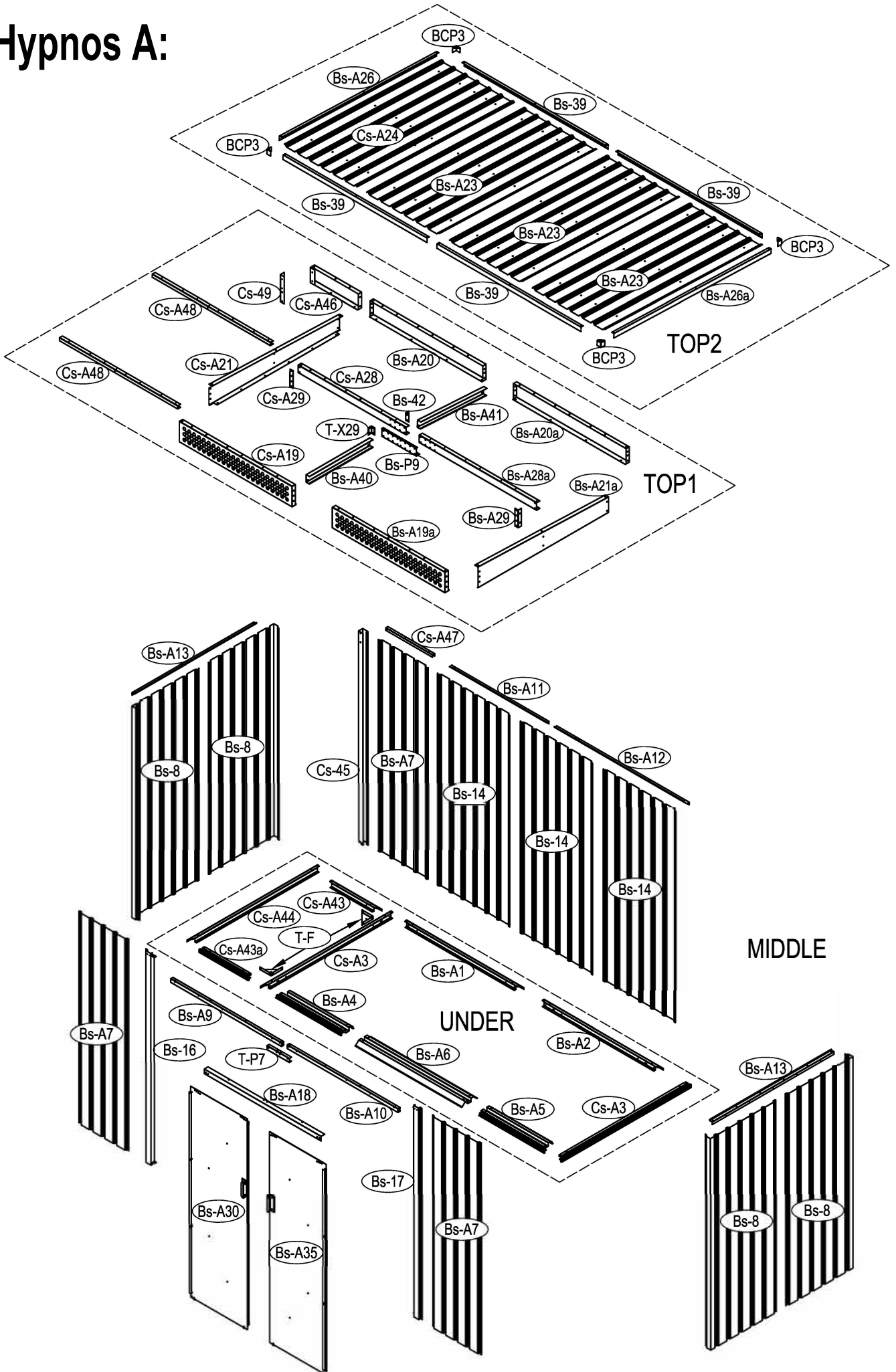

1

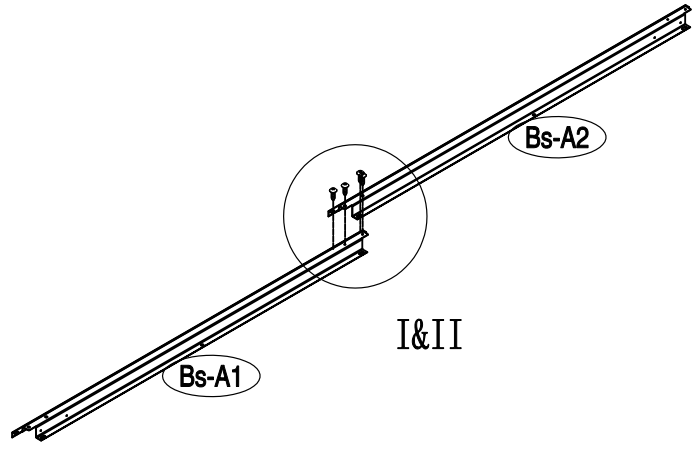
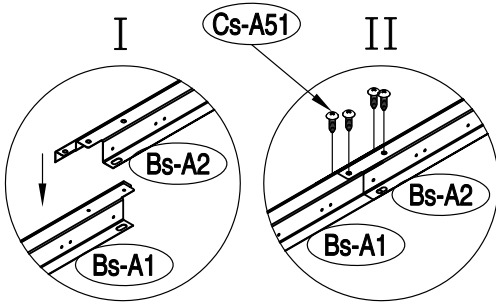

2

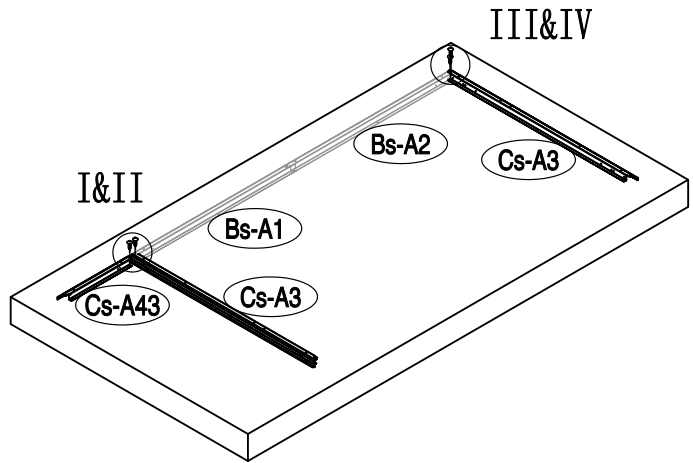
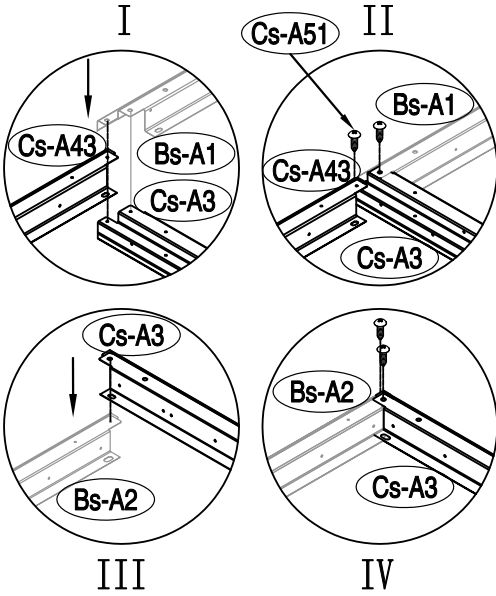

3

