

A	B	C (mm)	D
1	S236-0033	1723	600
2	S236-0035	900	400
3	S236-0036	900	400
4	S236-1065	1917	500
5	S236-1067	1917	480
6	S236-1070	1917	500
7	S236-2043	978	500
8	S236-2044	978	500
9	S236-3036	566	480
10	S236-3037	363	480
11	S236-3038	363	476
12	S236-9014	1927	376
13	S236-9324	1927	579
14	dr-561	561	22

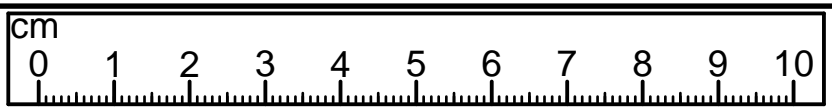

7x a128	7x b75	16x d1 Ø5x17 mm	28x f1 Ø8x30 mm	1x k53	4x k77 84x40/25 mm	22x l2	2x n1 h=22mm	14x n108 20x13x3,5,1	2x p1 Ø3,5x13 mm	9x p36 Ø4x25 mm	14x p38 Ø3,5x16 mm	14x p51 Ø3,5x15 mm
14x p55 Ø2,9x16 mm	28x r1 Ø15x12 mm #16	28x r42	24x s68 Ø 20mm									
									1x f35 Ø10x50 mm	1x n142 88x21x15/1,5	1x p17 Ø5x60 mm	2x p38 Ø3,5x16 mm

1 §2

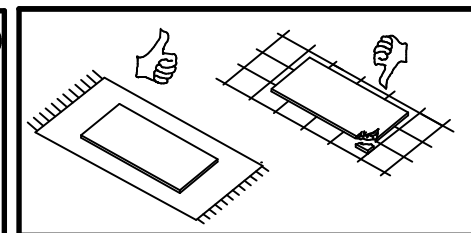
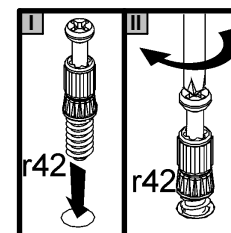
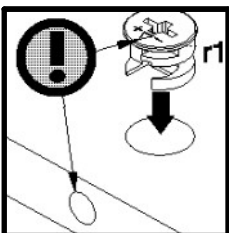
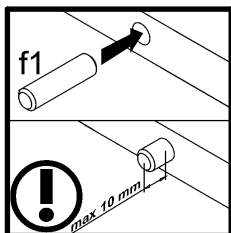
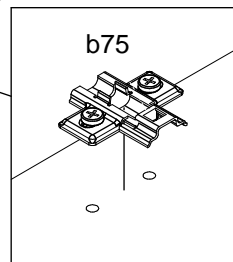
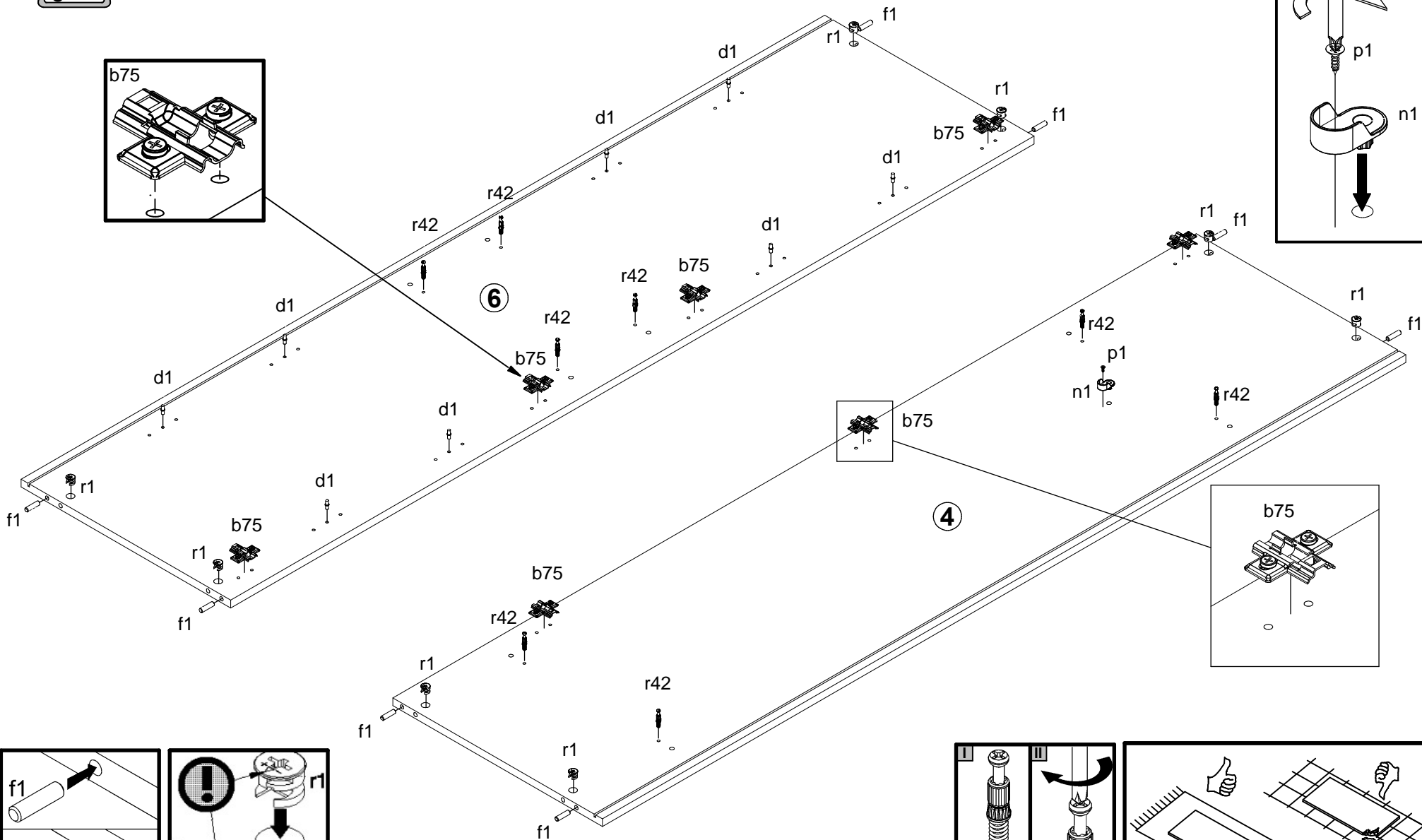
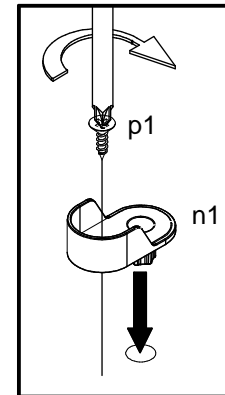
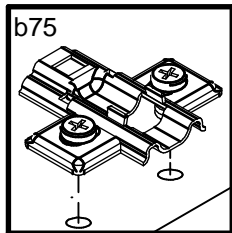

1 §2

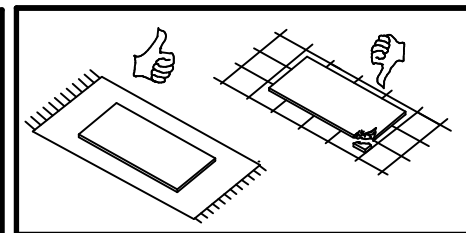
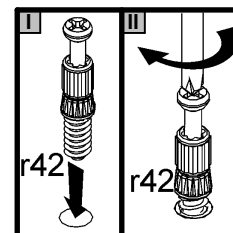
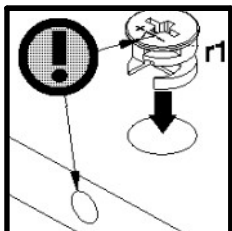
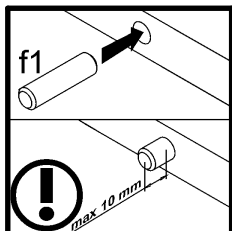
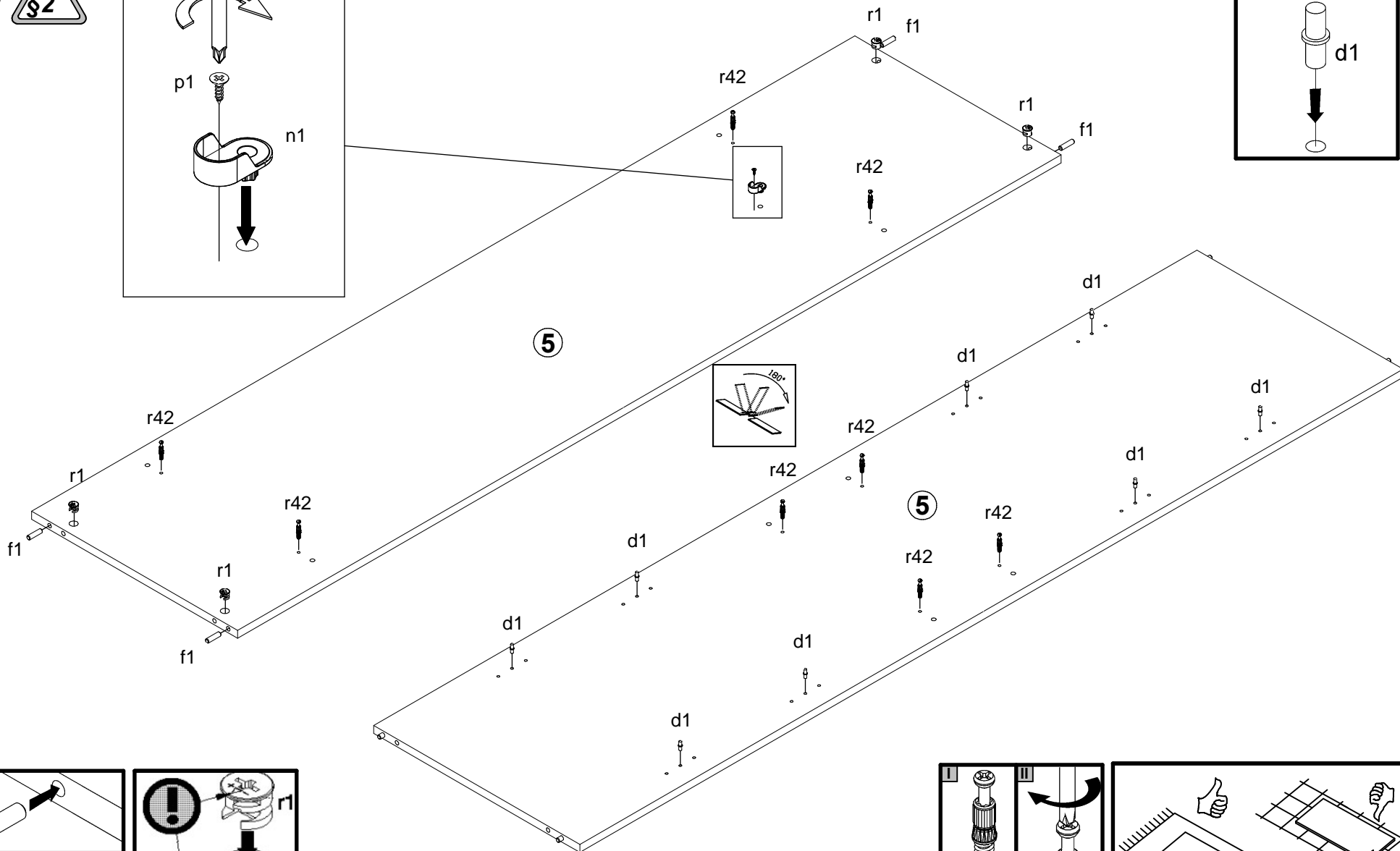
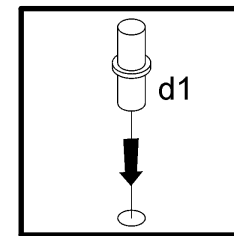
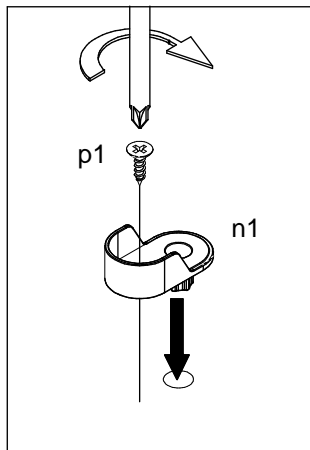

1

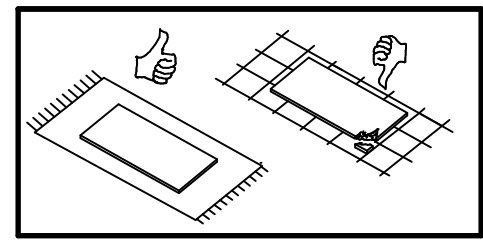
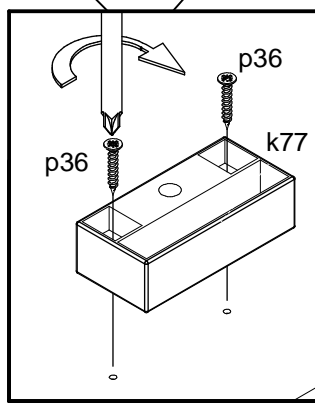
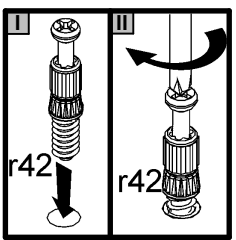
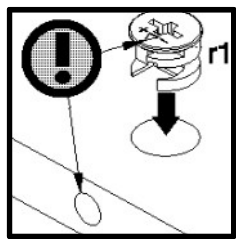
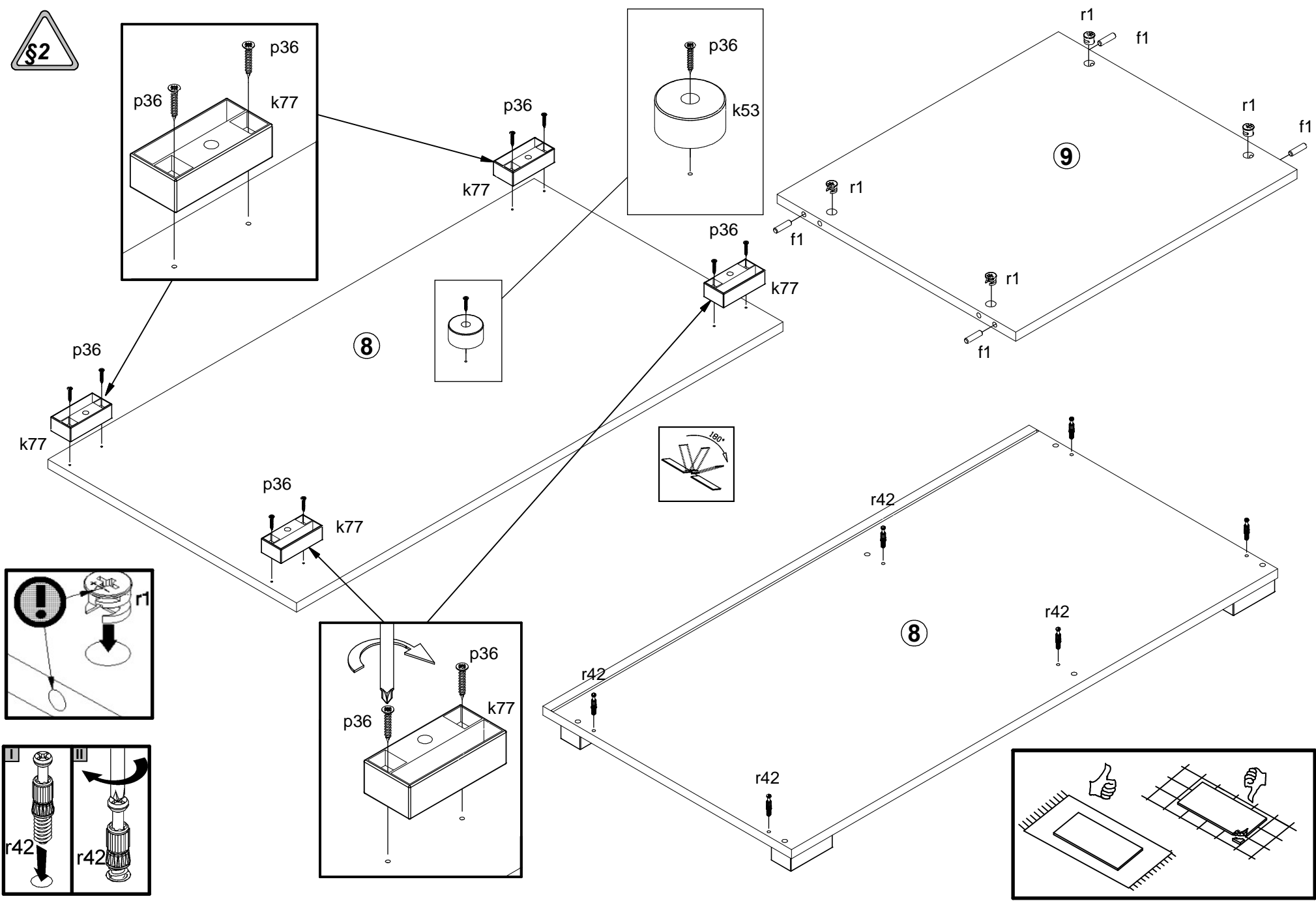

1 

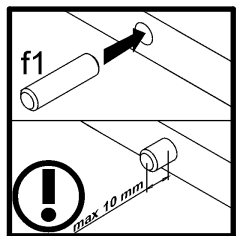
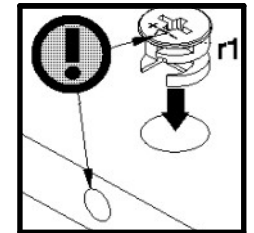
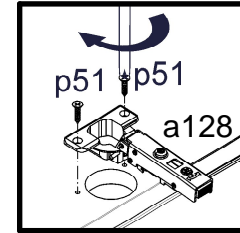
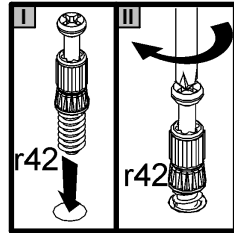
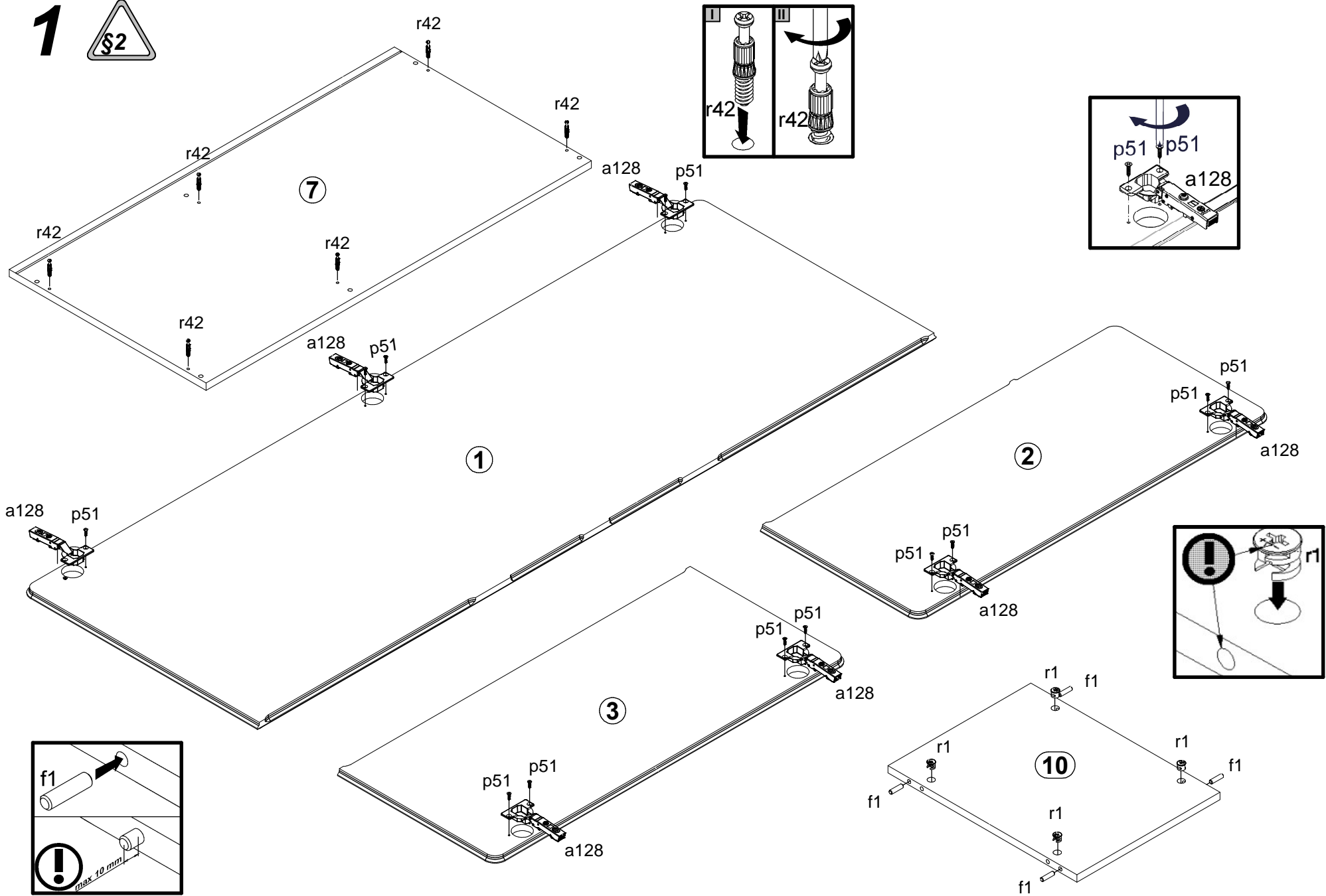



2

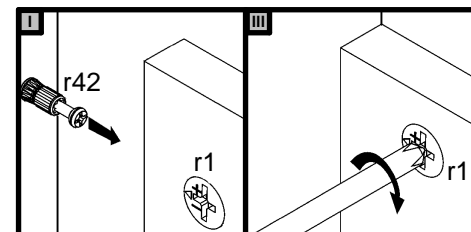
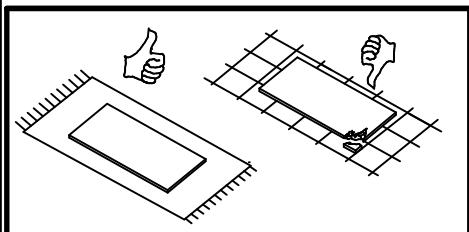
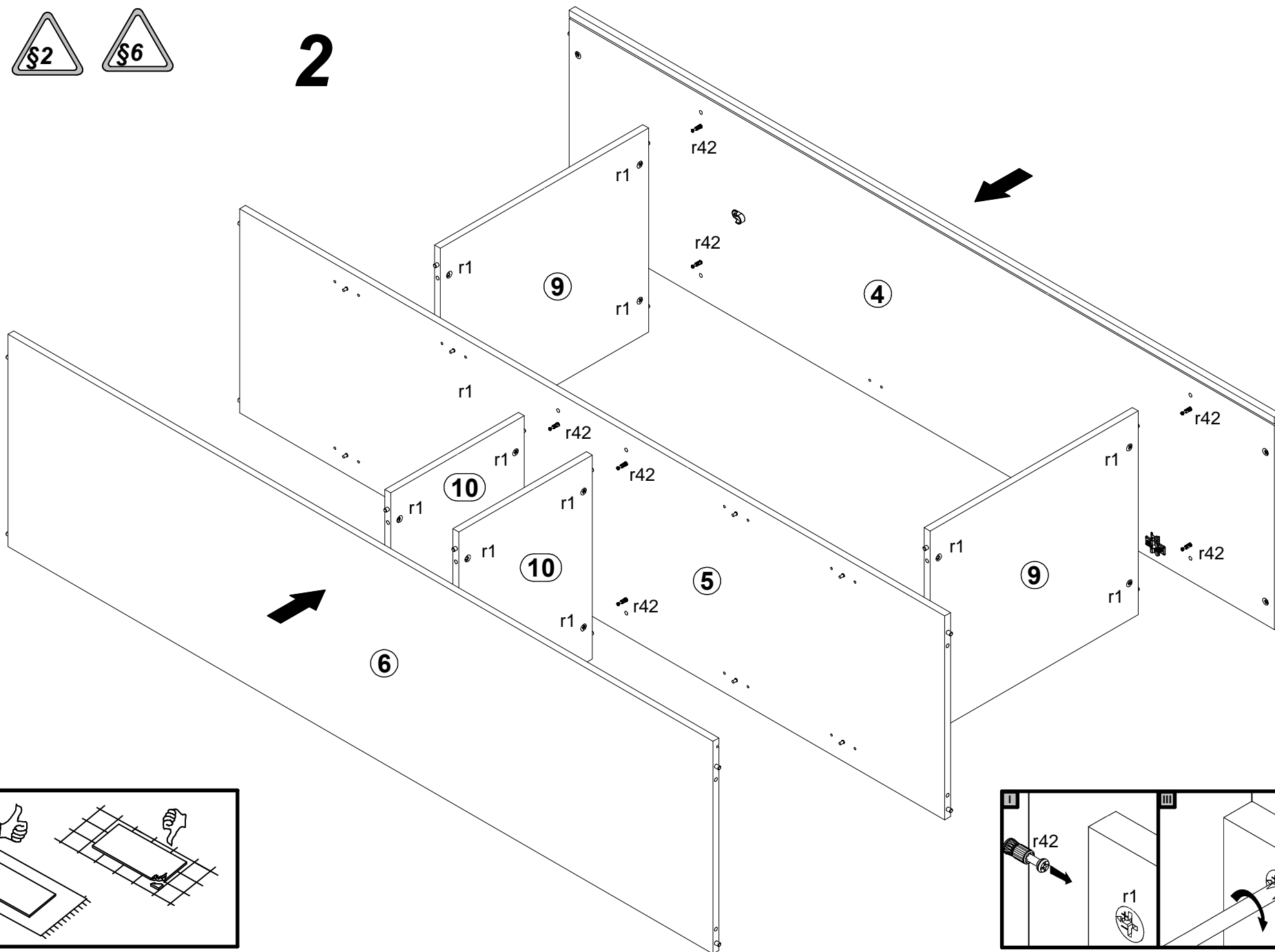



4

3

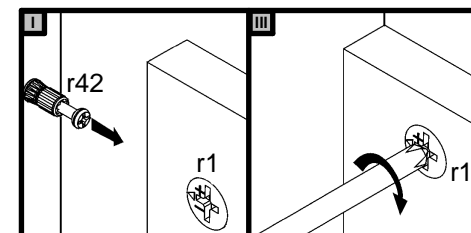
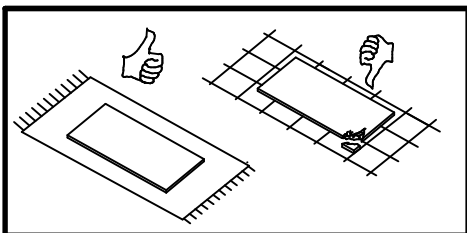
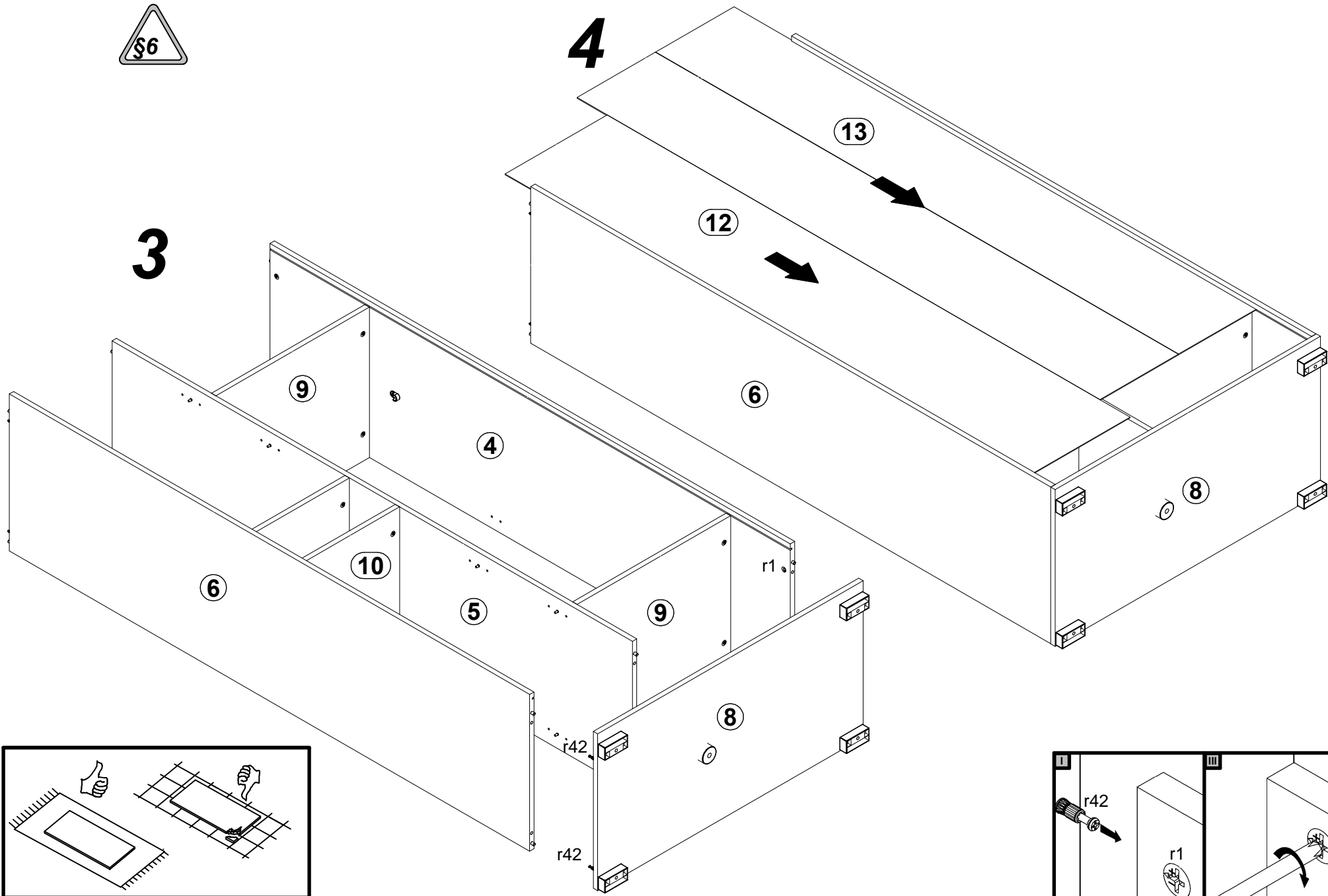

5

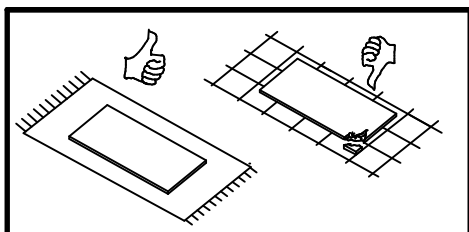
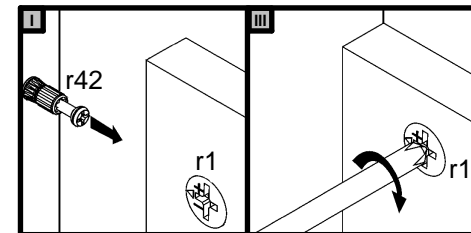
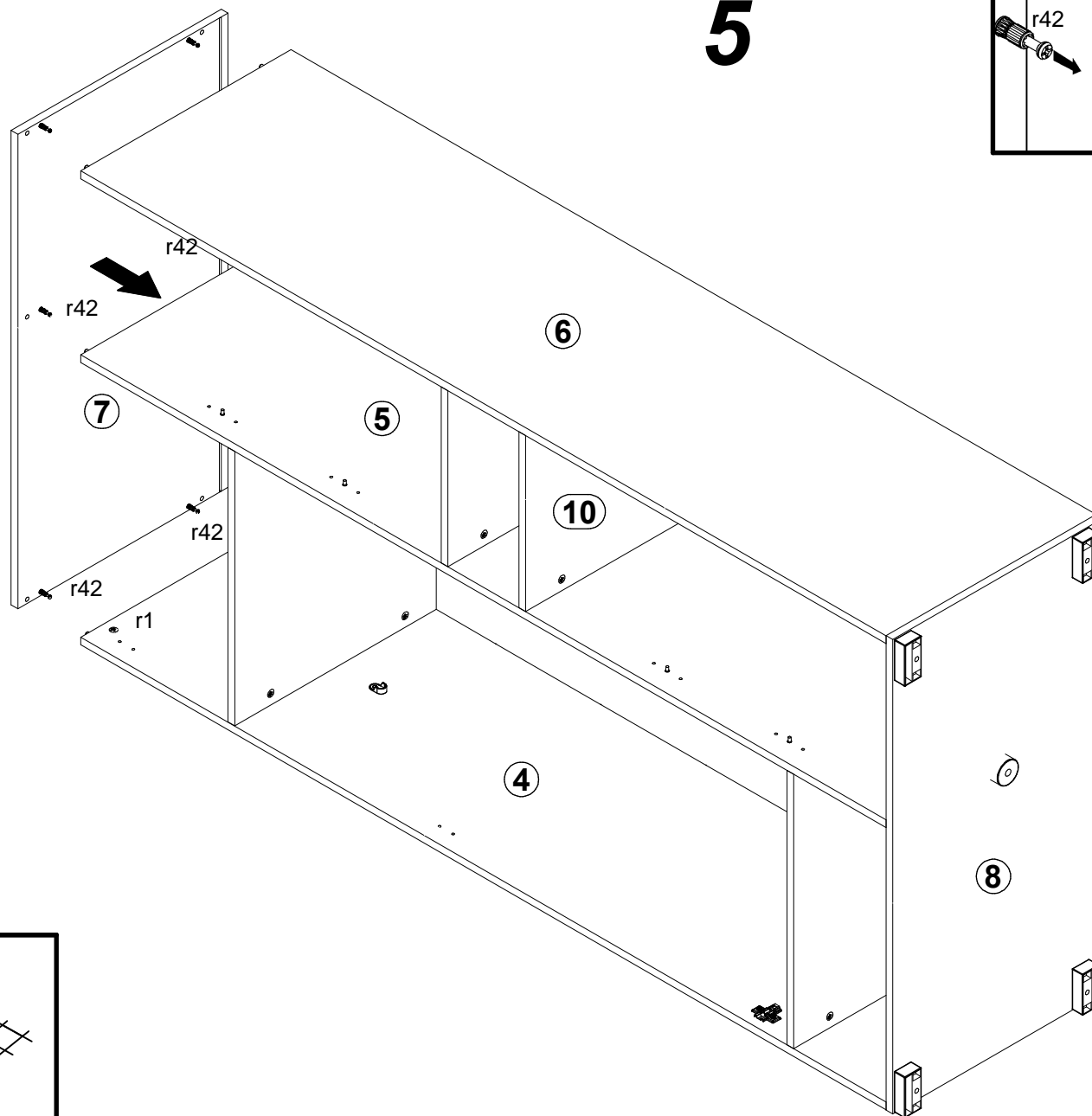

§6 6

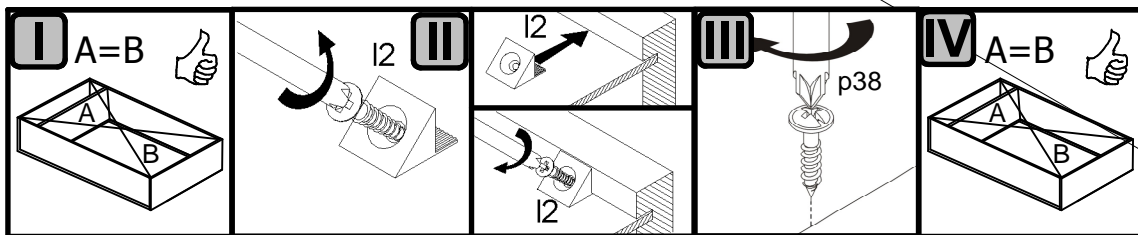
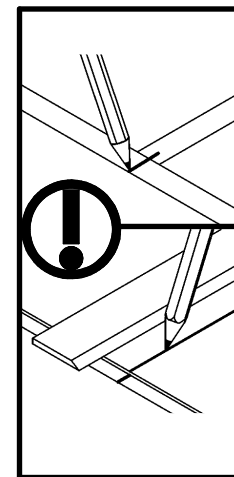
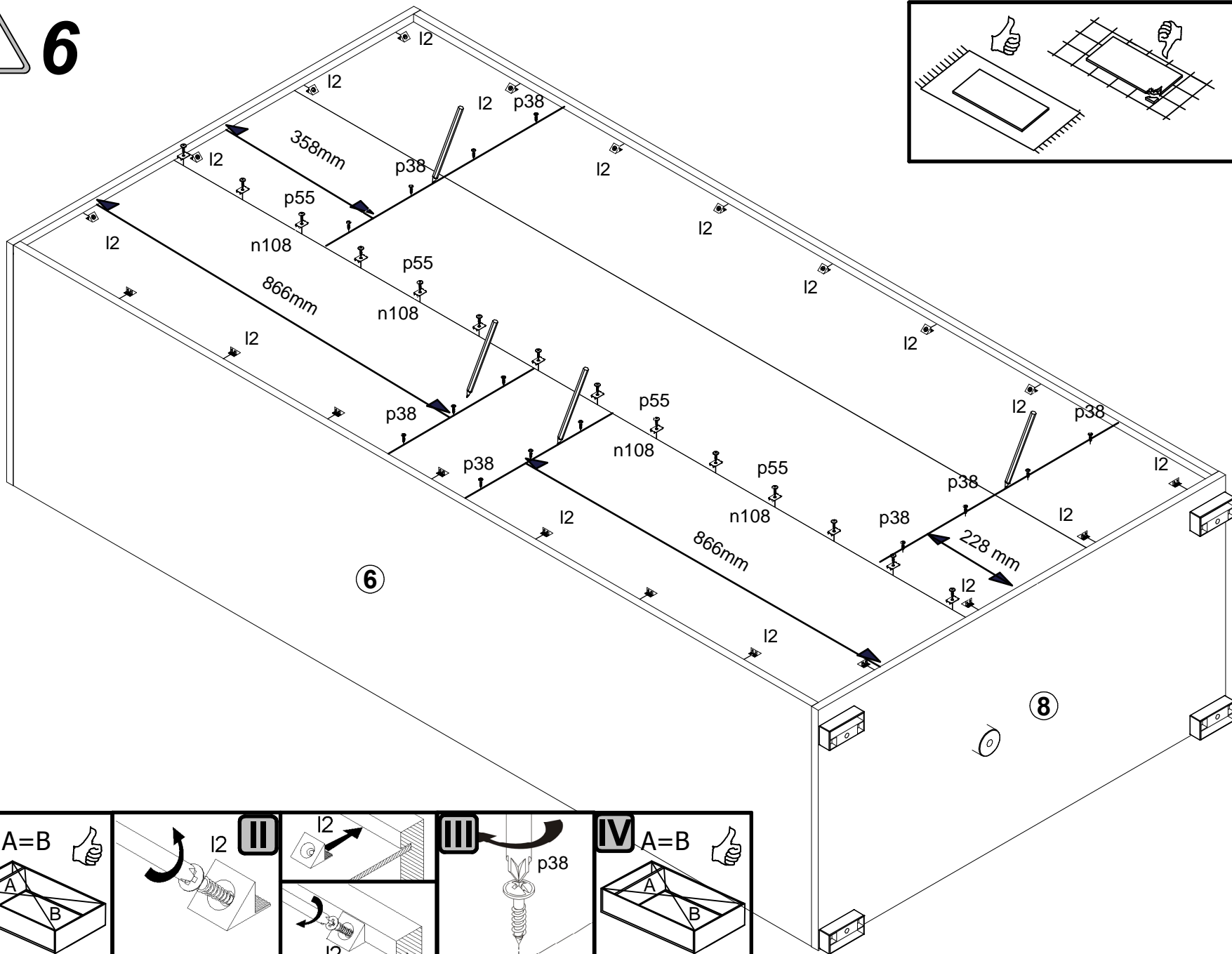
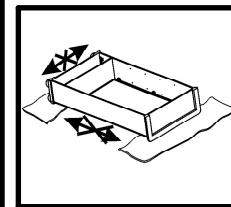
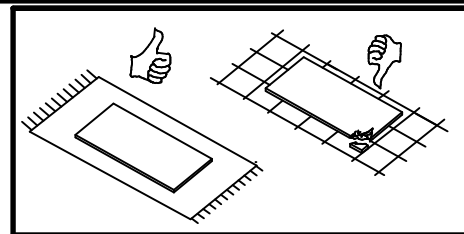

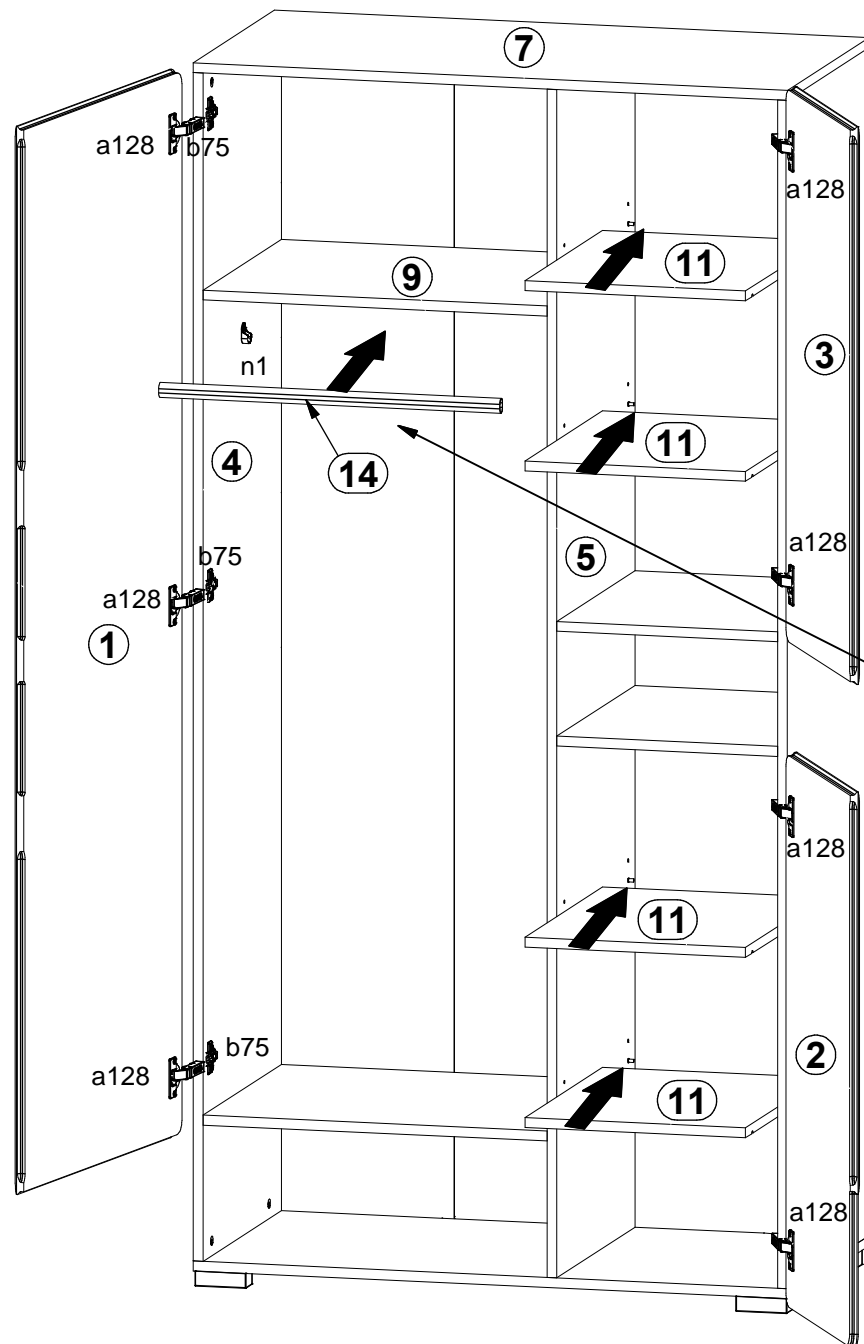

7

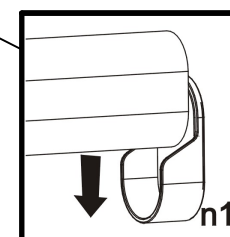
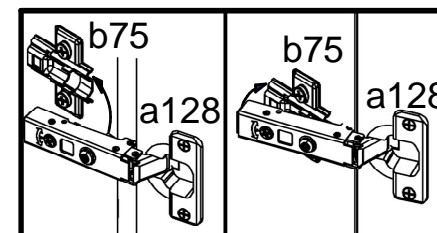

8



A	B	C (mm)		D
15	S236-1068	194	478	3/3
16	S236-1069	143	478	3/3
17	S236-2045	564	478	3/3
18	S236-2046	361	478	3/3
19	S236-9026	549	204	3/3
20	S236-9027	346	153	3/3

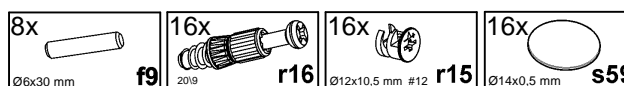
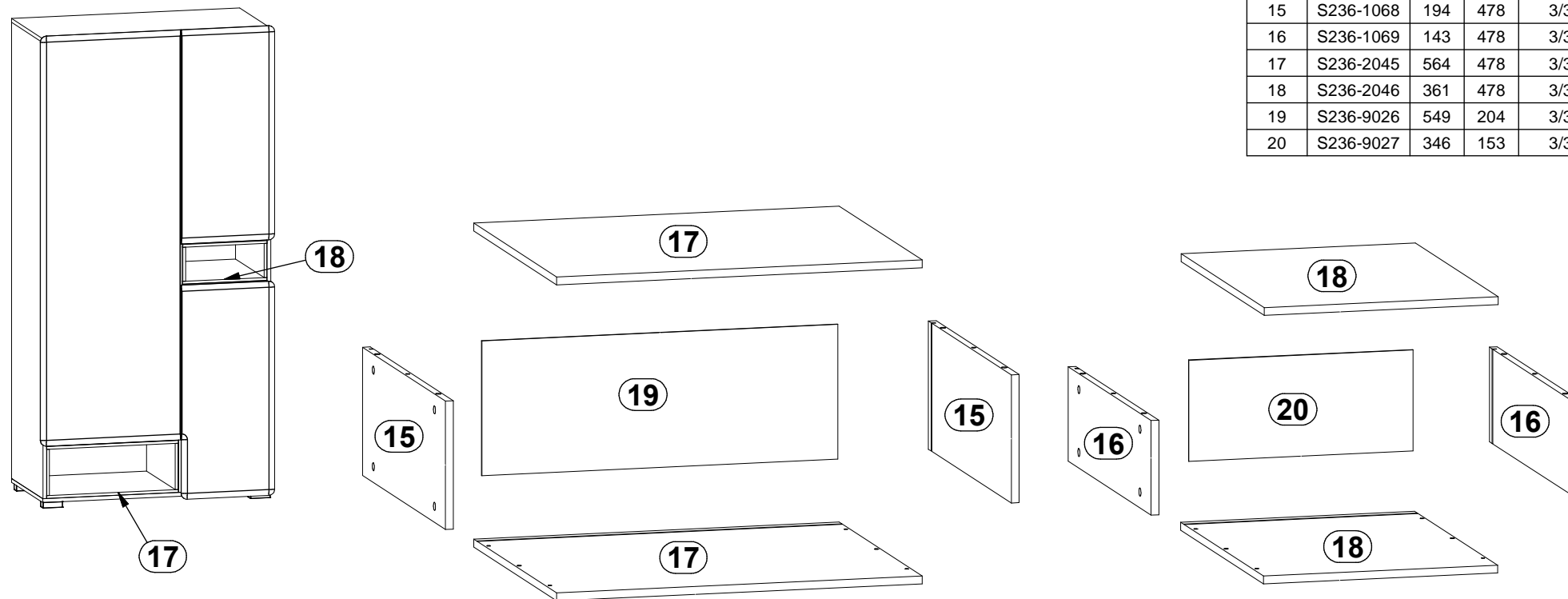

9

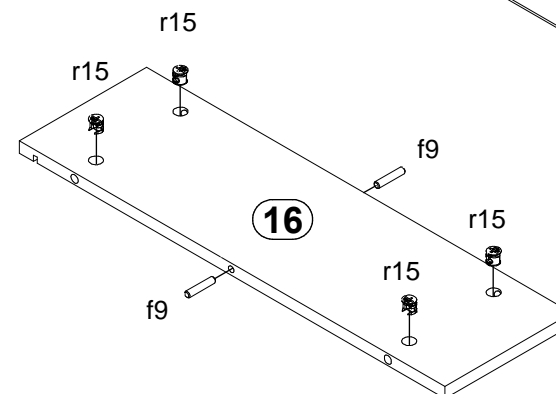
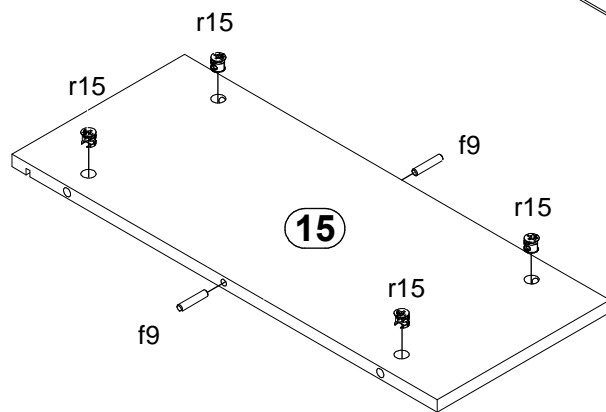
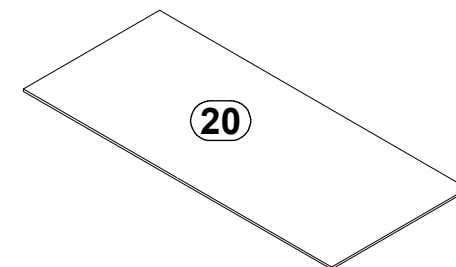
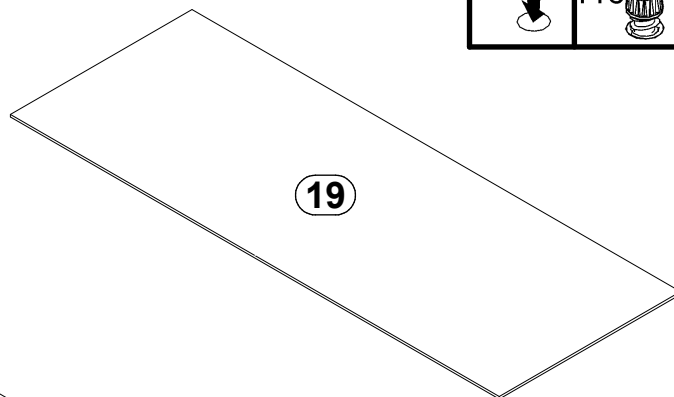
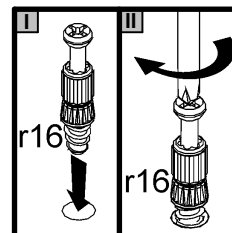
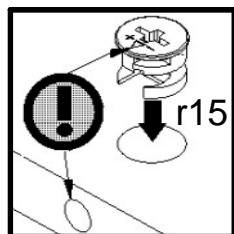
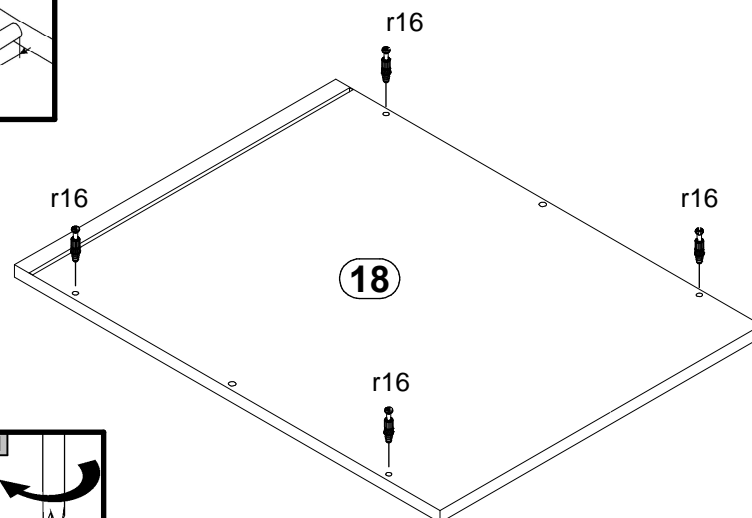
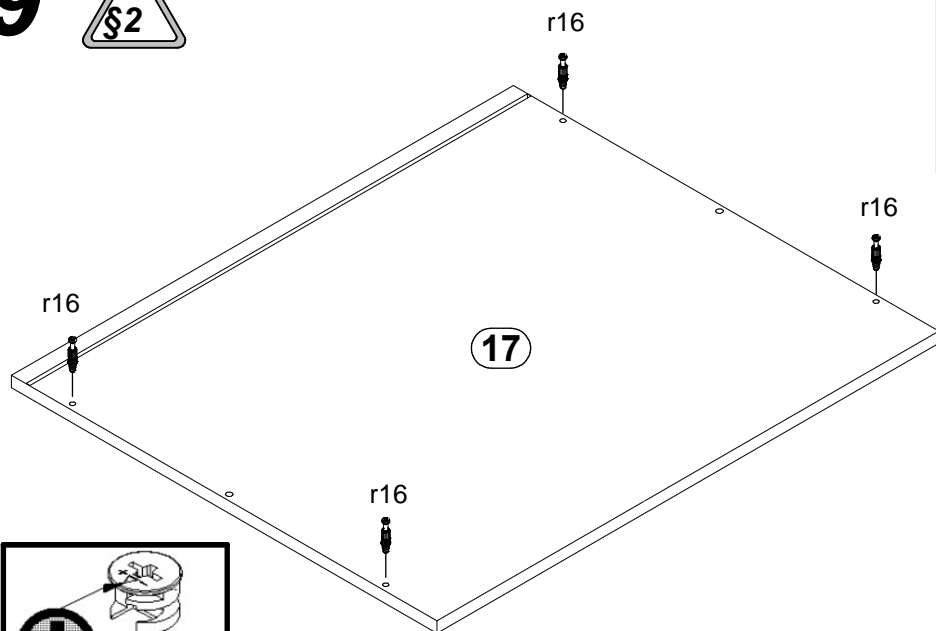
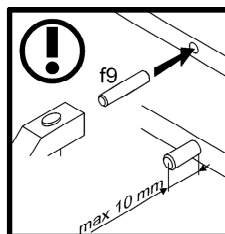

10

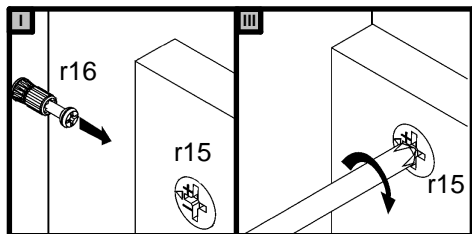
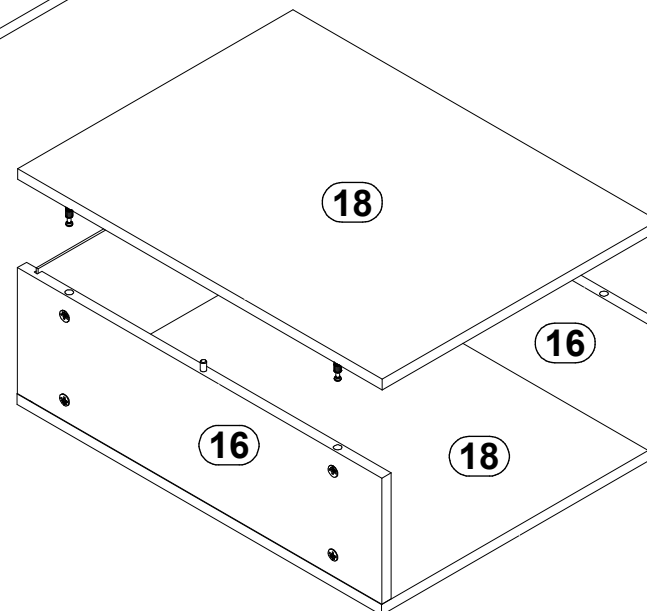
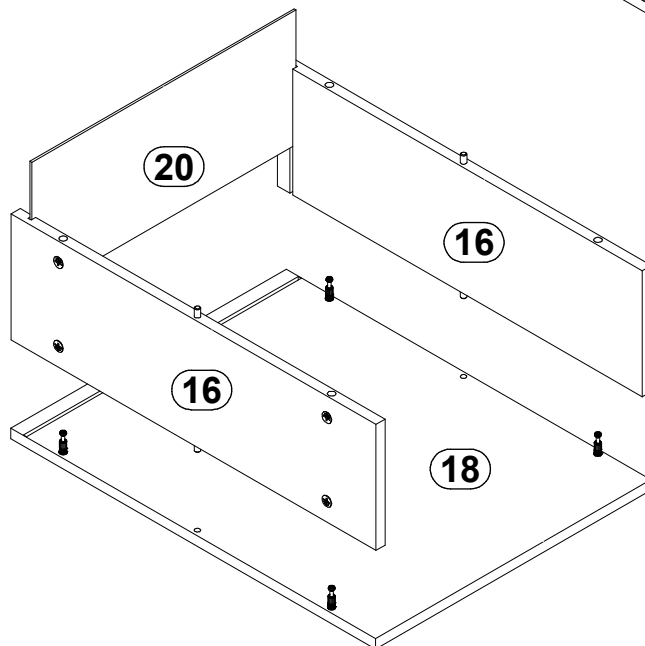
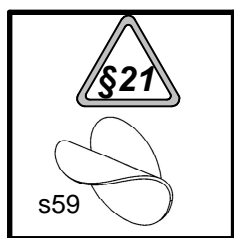
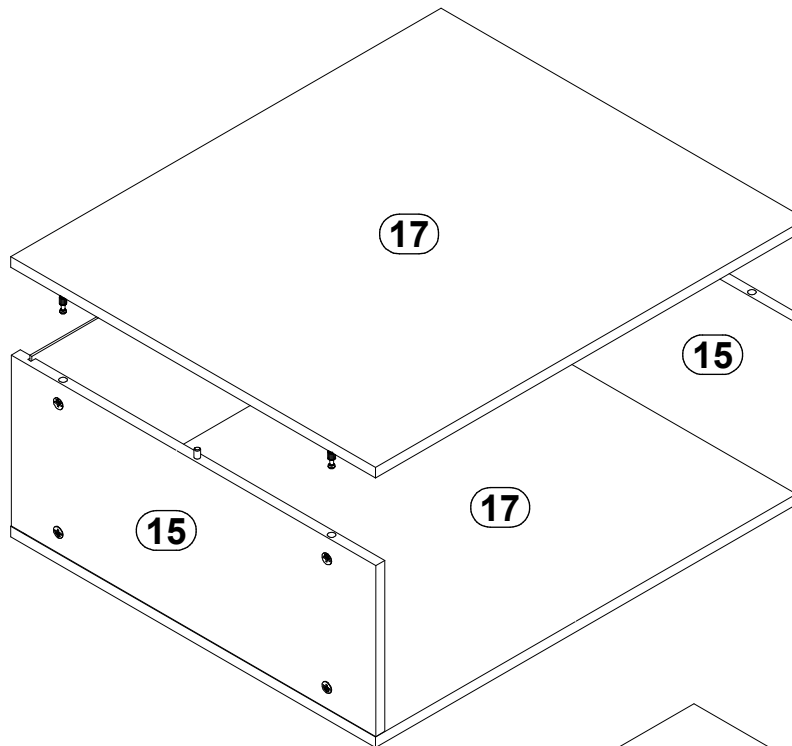
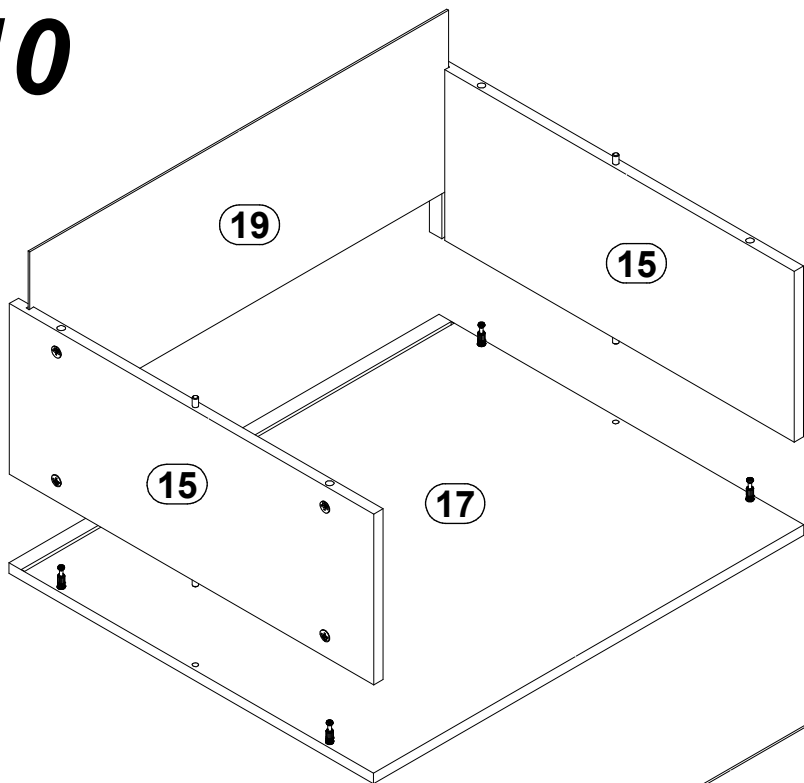

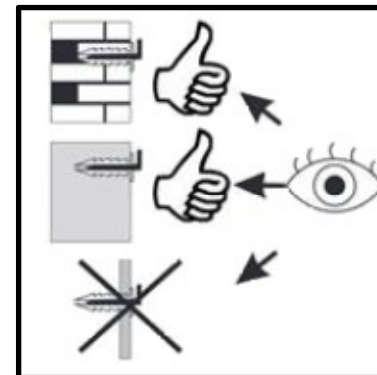
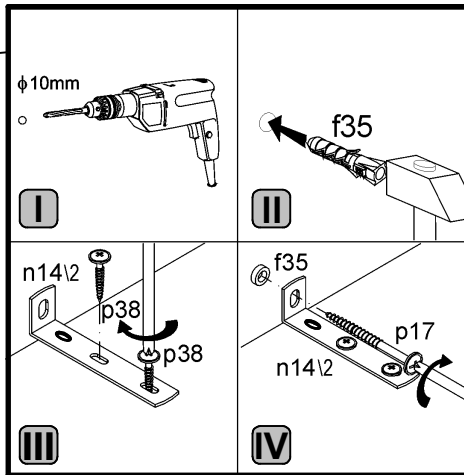
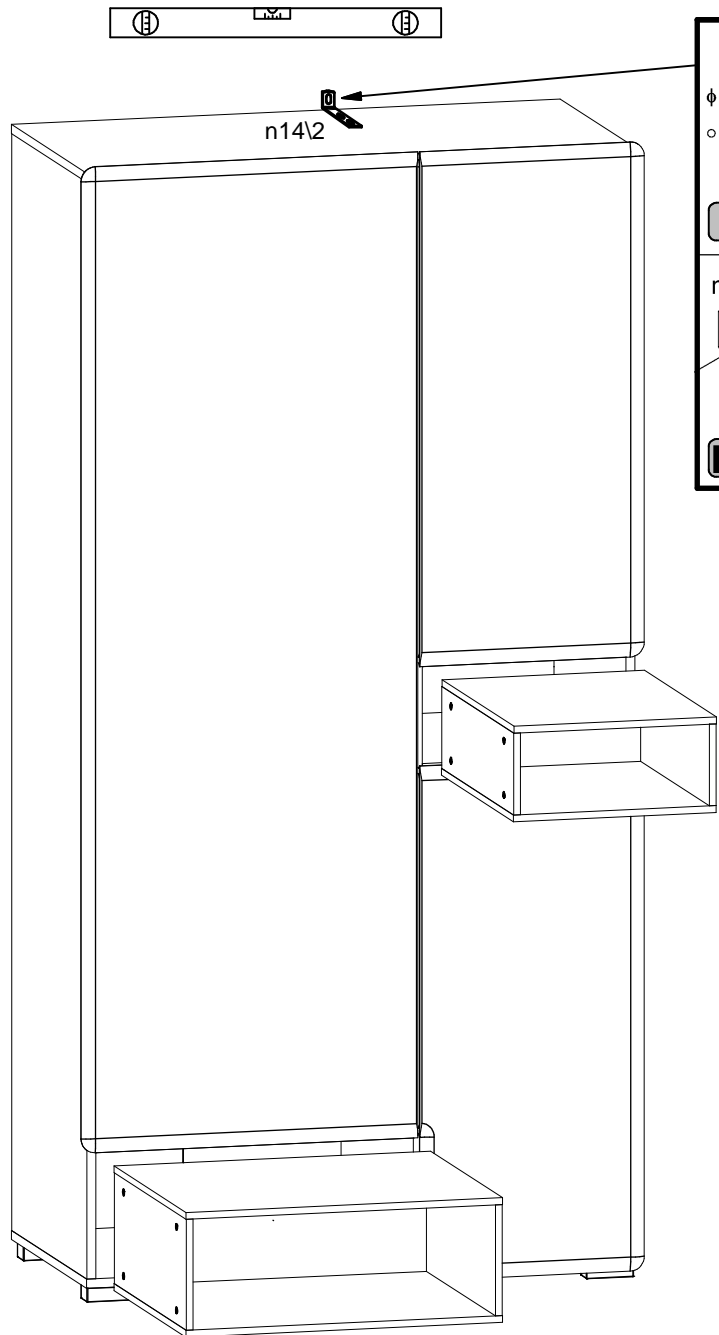

11

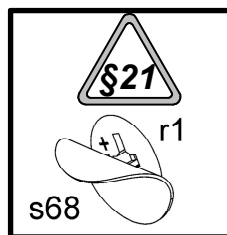
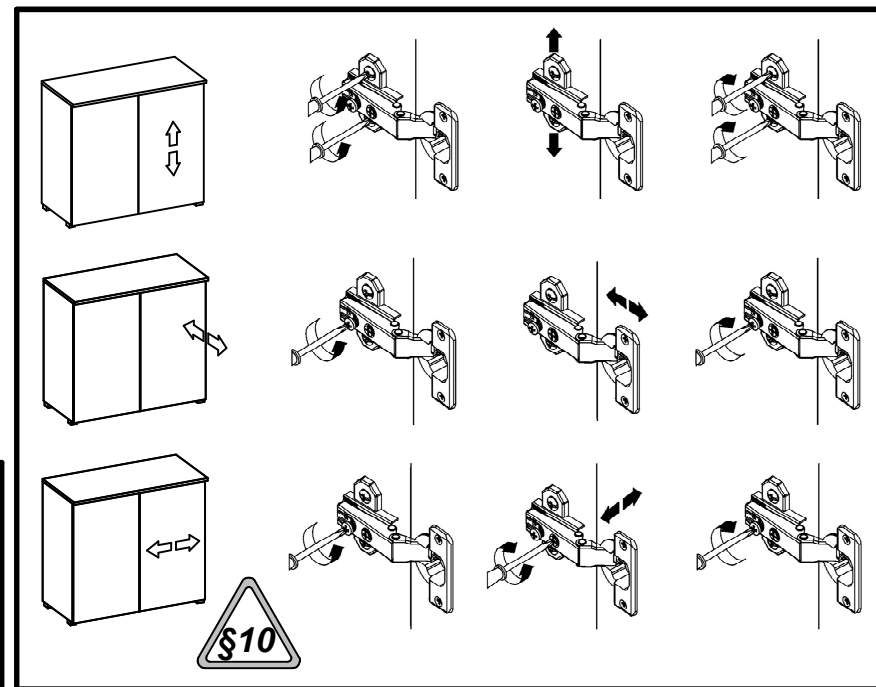
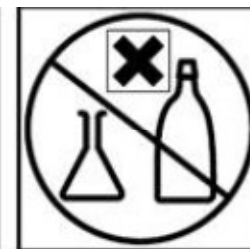
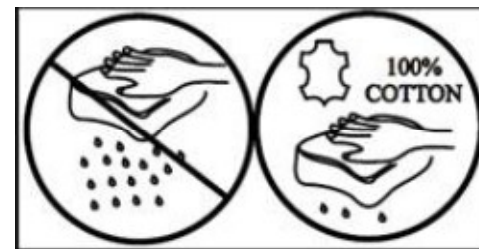

s68

